

**TAJIMA**

**Embroidery machine**

**SAI** 采

# **Operation Manual**

**MDP-S0801C(200×300)S**



Please keep this manual in handy even after use for future reference.



# Introduction

Thank you, and congratulations on your purchase of the SAI 彩 (MDP-SC). Before using this embroidery machine, make sure to thoroughly read this manual, so you are certain you have gained a sufficient grasp of all the procedures required to operate it.

## Manual organization

The manuals for this machine are organized as follows. Refer to the various sections as necessary.

Name	Purpose
Operation Manual	Refer to this manual when operating the machine.
Setup Guide	Refer to this manual when setting up the machine.

## Conventions used in this manual



Precautions that absolutely must be observed in order to prevent injury or damage with respect to persons using the machine or to other persons is indicated as follows:

Indication	Explanation
DANGER	Indicates that improper use can cause a hazardous situation that, if not avoided, will result in death or serious injury (*1)
WARNING	Indicates that improper use can cause a hazardous situation that, if not avoided, could result in death or serious injury (*1)
CAUTION	Indicates that improper use can cause a hazardous situation that, if not avoided, could result in minor or moderate injury, or property damage (*2)

(\*1) Electrical shocks, severe injuries, or fractured bones requiring hospitalization or a long series of hospital visits that may have long-lasting after effects.

(\*2) Injuries that do not require hospitalization or a long series of hospital visits.

Also note that the following symbols are used to denote statements that must be adhered to.

Symbol	Explanation
	This content is concerned with things that must be avoided.
	You risk electric shock if these instructions are not followed.
	In the interest of safety, these things must be adhered to.

## Disclaimers

The external appearance and specifications of this machine, or the contents of the manuals are subject to change without prior notice in the interest of improving the product.

Copying of the contents of this manual without permission is prohibited.

# Table of contents

<b>Important Safety Instructions</b> .....	<b>4</b>
WARNING stickers .....	13
<b>Chapter 1 Let's Learn the Names of Things and What They Do</b> .....	<b>14</b>
1.1 Machine main unit .....	14
1.2 Home screen .....	16
1.3 Basic operations on the screens .....	17
<b>Chapter 2 Getting Ready to Embroider</b> .....	<b>18</b>
2.1 Replacing needles .....	18
2.2 Threading the upper thread .....	19
2.3 Setting the under thread .....	23
2.3.1 Removing the bobbin case .....	23
2.3.2 Putting the bobbin in place .....	23
2.3.3 Placing in rotary hook .....	24
2.4 Setting up the embroidery frame .....	25
2.4.1 Mounting the fabric on the embroidery frame .....	25
2.4.2 Attaching an embroidery frame .....	26
<b>Chapter 3 How to Perform Embroidery</b> .....	<b>27</b>
3.1 Turning on the power .....	27
3.2 Starting the embroidery .....	29
3.2.1 Loading the design to be embroidered .....	29
3.2.2 Setting the needle number .....	31
3.2.3 Setting the orientation of the design and the start point .....	32
3.2.4 Moving the frame to the embroidery start point .....	33
3.2.5 Confirming that the design fits within the embroidery area .....	34
3.2.6 Selecting the speed .....	35
3.2.7 Starting the embroidery .....	36
3.2.8 Pausing the machine .....	38
3.2.9 When thread breaks during embroidery .....	40
3.3 Ending the embroidery .....	41
3.3.1 Removing the frame and fabric .....	41
3.3.2 Checking the tension of the upper thread .....	41
3.3.3 Turning off the machine's power .....	42
<b>Chapter 4 Getting the Most Out of the Machine</b> .....	<b>43</b>
4.1 Hiding icons in the Home screen .....	43
4.2 Storing a design as a favorite or removing it .....	44
4.3 Loading designs from records or favorites .....	46
4.4 Loading a design from a PC using a LAN cable .....	47
4.5 Loading a design using a barcode reader .....	48
4.6 Editing the steps of a design .....	49
4.6.1 Needle No. Setting screen .....	50
4.6.2 Setting the needle number .....	51
4.6.3 Bringing the frame out .....	52
4.6.4 Pausing .....	53
4.6.5 Repeating step .....	54

4.7 Setting the thread colors . . . . .	55
4.7.1 Selecting from the database . . . . .	55
4.7.2 Selecting from the color palette . . . . .	57
4.8 Bringing the frame out quickly . . . . .	58
4.9 Returning frame/advancing frame according to design . . . . .	59
4.10 Manual operation . . . . .	60
4.10.1 Moving the frame manually . . . . .	60
4.10.2 Manually changing the needle position . . . . .	61
4.10.3 Trimming the thread manually . . . . .	62
4.11 Using the laser crosshair marker . . . . .	63
4.12 Using design creation software . . . . .	64
<b>Chapter 5 Lettering Embroidery . . . . .</b>	<b>65</b>
5.1 Lettering embroidery . . . . .	65
<b>Chapter 6 Setting the Machine . . . . .</b>	<b>69</b>
6.1 Adjusting the embroidery settings . . . . .	69
6.1.1 Detecting thread breakage . . . . .	70
6.1.2 Sewing return stitches at the beginning of the embroidery . . . . .	71
6.1.3 Changing length of upper thread after trimming . . . . .	71
6.1.4 Moving the needle bar case after the design has been embroidered . . . . .	72
6.1.5 Settings for automatic thread trimming . . . . .	72
6.2 Frame settings . . . . .	73
6.2.1 Setting the type of frame to be used . . . . .	73
6.2.2 Memorizing the frame origin . . . . .	74
6.2.3 Memorizing the frame origin upon power up . . . . .	76
6.2.4 Setting the permissible range of movement for the frame . . . . .	77
6.2.5 Returning the frame to its original position after manually moving it . . . . .	78
6.3 Performing network settings . . . . .	79
6.4 Setting the date and time . . . . .	81
6.5 Setting the language used for display on the operation panel . . . . .	82
6.6 Displaying information about the machine . . . . .	83
6.7 Changing the wallpaper color on the operation panel . . . . .	84
6.8 Other settings . . . . .	85
<b>Chapter 7 Using Optional Accessories . . . . .</b>	<b>86</b>
7.1 Using the cap frame . . . . .	86
7.1.1 Attaching the cap frame unit to the machine . . . . .	86
7.1.2 Positioning a cap on the cap frame . . . . .	88
7.1.3 Positioning the cap frame on the cap frame unit . . . . .	90
7.1.4 Changing the settings for the frame . . . . .	91
7.1.5 Removing the cap frame . . . . .	92
<b>Chapter 8 Appendix . . . . .</b>	<b>93</b>
8.1 Producing beautiful embroidery . . . . .	93
8.2 Maintenance . . . . .	94
8.2.1 Cleaning the machine . . . . .	94
8.2.2 Lubrication . . . . .	95
8.3 Troubleshooting . . . . .	98
8.3.1 What to do when an error message is displayed . . . . .	98
8.3.2 What to do when the embroidery results are not as expected . . . . .	102
8.4 Specifications . . . . .	104
<b>Index . . . . .</b>	<b>105</b>

# IMPORTANT SAFETY INSTRUCTIONS

Read all instructions before using this appliance.

When using an electrical appliance, basic safety precautions should always be followed, including the following:

## DANGER

### To reduce the risk of electric shock:

- ⊘ An appliance should never be left unattended when plugged in. Always unplug this appliance from the electric outlet immediately after using and before cleaning.

## WARNING

Fire, electrical shock, or injury may result if the following instructions are not adhered to.

### ⊘ Use only for intended purpose

This machine is designed for household use or for commercial use. Use the product only for embroidering clothing, textiles, or other similar fabrics.

### ⊘ Do not disassemble, repair, or modify the machine

If the machine fails to operate normally, do not attempt to repair it on your own. Contact your sales dealer.

### ⊘ Keep internally implanted electronic medical devices away from the machine

Powerful magnets, which can cause the malfunction of heart pacemakers and other devices, are used inside the machine. Whenever any unusual feelings (dizziness, lightheadedness, palpitation) are experienced, immediately move away from the machine, or stop using it.

**⚠ If smoke, strange odors, or abnormal sounds are emitted**

Switch OFF the power switch, and pull out the plug of the power cord from the outlet. Then contact your sales dealer.

**⚠ To prevent fire, electrical shock, and malfunctions**

In each of the following situations, switch OFF the power switch, and pull out the plug of the power cord from the outlet. Otherwise, there is a risk of fire, electrical shock, or malfunction.

- After using the machine
- When not intending to use the machine for a long period of time
- After a power outage has occurred while the machine was being used
- Before performing maintenance on the machine
- Before leaving the room in which the machine is located
- When thunder is heard

**⚡ Handle the power cord, power adapter, and power plugs carefully**

Make sure to observe the following. Fire or electrical shock may result from improper handling.

- Use only the supplied power cord and power adapter.
- Avoid damaging the power cord, all other wiring and cords, and the power adapter. Do not modify, heat, bundle, or apply undue force (pull on or twist) to these parts.
- Plug in the power plug securely so it is inserted all the way.
- Never plug in or unplug the power plug with wet hands
- Immediately stop using the machine if the power cord is damaged, has exposed wires, or has broken wires; then, replace the power cord with a new one.

**⚡ Be sure to use a power supply of the correct voltage**

Do not use the machine with supply voltages that are different from what is indicated. Avoid using outlets that are shared by multiple devices.

**⚡ Be careful so as to not allow any water, chemicals, etc., to get into the machine**

Do not allow any water or chemicals to get into the electrical portions of the machine. This can cause short circuits in the circuitry, which can lead to fire or electrical shock. If water or chemicals have entered the machine, switch OFF the power switch, and unplug the power plug from the outlet. Then, contact your sales dealer.

**To reduce the risk of burns, fire, electric shock, or injury to persons:**

**⊘ Do not allow children to use the machine as a toy**

Do not allow to be used as a toy. Close attention is necessary when this appliance is used by or near children.

**⊘ If the machine is damaged**

Never operate this appliance if it has a damaged cord or plug, if it is not working properly, if it has been dropped or damaged, or dropped into water. Please consult the sales dealer and use this appliance after the examination, repair, electrical or mechanical adjustment has been made. Never drop or insert any object into any opening.

**⊘ Never block any of the machine's air openings**

Never operate the appliance with any air openings blocked. Keep ventilation openings of the machine free from the accumulation of lint, dust, and loose cloth.

**⊘ Check the condition of the needle**

Do not use bent needles.

**⊘ Do not touch the fabric while embroidery is being carried out**

Do not pull or push fabric while stitching. It may deflect the needle causing it to break.

**⊘ The machine is designed for indoor use only**

Do not use outdoors.

**⊘ Do not use sprays around the machine**

Do not operate where aerosol (spray) products are being used or where oxygen is being administered.

**⊘ When unplugging the power cord**

Do not unplug by pulling on cord. To unplug, grasp the plug, not the cord.



**To reduce the risk of burns, fire, electric shock, or injury to persons:****❗ Use only for intended purpose**

Use this appliance only for its intended use as described in this manual. Use only attachments recommended by the manufacturer as contained in this manual.

**❗ Keep fingers and face away from the machine while it is operating**

Keep fingers away from all moving parts. Special care is required around the machine needle.

**❗ Use specified needle plates**

Always use the proper needle plate. The wrong plate can cause the needle to break.

**❗ When preparing or adjusting**

Switch the machine off ("O") when making any adjustments in the needle area, such as threading needle, changing needle, threading bobbin, or changing presser foot, etc.

Always unplug machine from the electrical outlet when removing covers, lubricating, or when making any other user servicing adjustments mentioned in the instruction manual.

**❗ When turning off the power**

To disconnect, turn all controls to the off ("O") position, then remove plug from outlet.

**❗ Proper grounding is important**

Connect this appliance to a properly grounded outlet only. See GROUNDING INSTRUCTIONS (For USA and Canada only).

**❗ [For European countries only]**

This appliance can be used by children aged from 8 years and above and persons with reduced physical, sensory or mental capabilities or lack of experience and knowledge if they have been given supervision or instruction concerning use of the appliance in a safe way and understand the hazards involved. Children shall not play with the appliance. Clearing and user maintenance shall not be made by children without supervision.

# SAVE THESE INSTRUCTIONS

## CAUTION

Minor injury or property damage may result if the following instructions are not adhered to.

### **Avoid unsuitable environments for using/storing the unit**

Do not use or store the machine in any of the following places: Otherwise, malfunction, discoloration, or deformation may occur.

- Outdoors
- Locations exposed to direct sunlight
- Places where water or any other liquid could come in contact the unit
- Places located near open flames, heaters, air-conditioning units, etc.
- Places with large amounts of dust or moisture

### **Do not use or store unit in places subject to extreme temperatures**

Use and store the machine in places where the temperature ranges from 5° to 40°C.

### **Do not place any liquids or small metallic objects nearby**

Do not place any containers with liquids, or small metallic objects such as screws in the vicinity of the machine.

### **Do not remove the cover from the machine**

The machine must never be used while its cover is removed.

### **Do not look directly at laser beam**

This machine contains a Class 1 laser device, which complies with the safety regulations stipulated by the FDA Radiation Emitting Products Regulation (21 CFR Subchapter J) and the international "Safety of Laser Products" standards of IEC60825-1. Do not look directly at the laser beam, or view it through a lens or other observational-use optical instrument.

**❗ If the machine is dropped, damaged, or fails to function properly**  
Immediately stop use of the machine and contact your sales dealer.

**❗ When air conditioning devices are used**

Take care so as not to allow the airflow from an air conditioning device to directly strike the machine. This will help prevent irregularities in the embroidery threads.

**❗ When moving the machine**

When moving the machine, make sure to enlist the help of at least other persons, and grasp it at the specified locations on the bottom. Move it carefully while paying attention to the surroundings.

**❗ When installing the machine**

Place the machine on a flat, level table or other stable surface before using it. Make sure to allow sufficient space, at least 20 cm, at the right and left sides of the machine, and between it and any walls or other obstructions, so the movement of the frame is not blocked.

**❗ Observation and supervision required in the following cases**

A supervisor should be on hand to provide guidance when the machine is to be used by persons with disabilities, persons who lack the knowledge and experience to operate a machine properly, or children. Also, children should be supervised to ensure that they do not play with the machine. If using USB memory (USB flash drives), due care should be taken if children are present in order to prevent ingestion.

**❗ Use fingers or stylus for operation panel**

Operations using the operation panel can be performed using fingers or the supplied stylus.

**❗ Maintenance for the machine is important**

Be sure to oil the specified places and perform the necessary cleaning at the specified intervals.

## GROUNDING INSTRUCTIONS (For USA and Canada only)

This product must be grounded. In the event of malfunction or breakdown, grounding provides a path of least resistance for electric current to reduce the risk of electric shock. This product is equipped with a cord having an equipment-grounding conductor and a grounding plug. The plug must be plugged into an appropriate outlet that is properly installed and grounded in accordance with all local codes and ordinances.



### DANGER

- ⊘ Improper connection of the equipment-grounding conductor can result in a risk of electric shock. The conductor with insulation having an outer surface that is green with or without yellow stripes is the equipment-grounding conductor. If repair or replacement of the cord or plug is necessary, do not connect the equipment-grounding conductor to a live terminal.
- ⊘ Do not modify the plug provided with the product - if it will not fit the outlet, have a proper outlet installed by a qualified electrician.
- ⚠ Check with a qualified electrician or serviceman if the grounding instructions are not completely understood, or if in doubt as to whether the product is properly grounded.

**! [When the product is used in a nominal rating up to 120V]**

This product is for use on a nominal 120V circuit, and has a grounding plug that looks like the plug illustrated in sketch A in Figure-1. A temporary adaptor, which looks like the adaptor illustrated in sketches B and C, may be used to connect this plug to a 2-pole receptacle as shown in sketch B if a properly grounded outlet is not available. The temporary adaptor should be used only until a properly grounded outlet can be installed by a qualified electrician. The green colored rigid ear, lug, and the like, extending from the adaptor must be connected to a permanent ground such as a properly grounded outlet box cover. Whenever the adaptor is used, it must be held in place by the metal screw.

Figure-1

Grounding methods

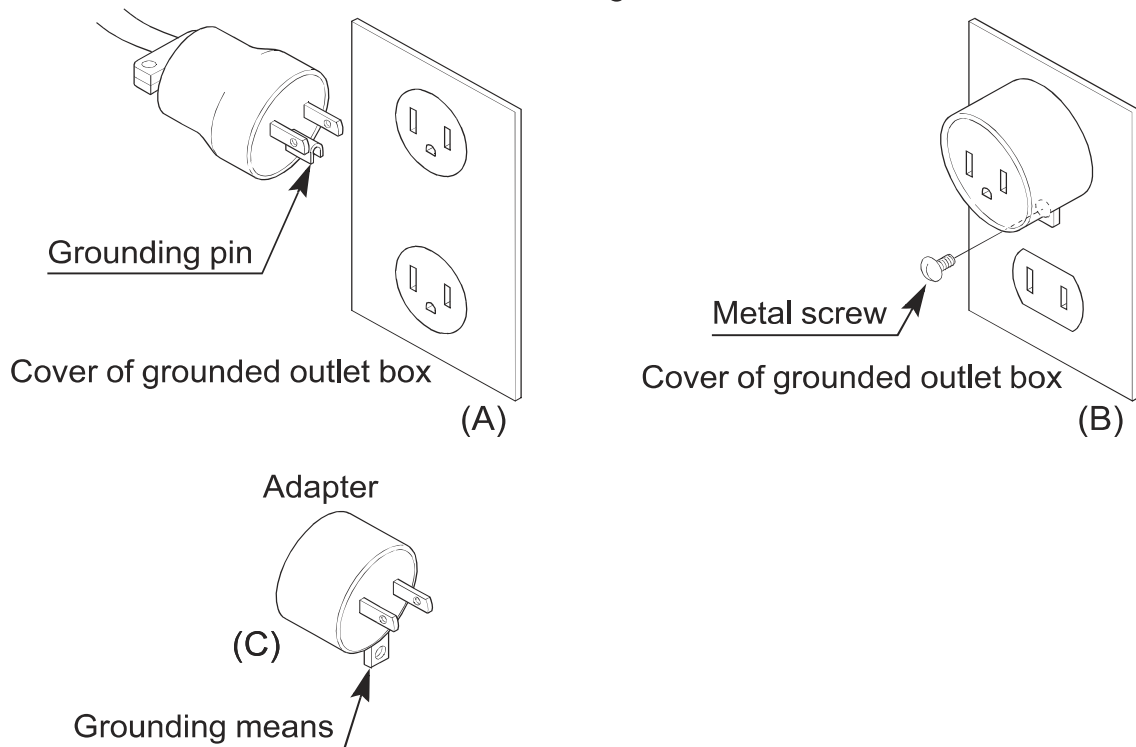

## Statement on FCC Rules (For USA Only)

This device complies with part 15 of the FCC Rules. Operation is subject to the following two conditions: (1) This device may not cause harmful interference, and (2) this device must accept any interference received, including interference that may cause undesired operation.

Note: This equipment has been tested and found to comply with the limits for a Class B digital device, pursuant to part 15 of the FCC Rules. These limits are designed to provide reasonable protection against harmful interference in a residential installation. This equipment generates, uses and can radiate radio frequency energy and, if not installed and used in accordance with the instructions, may cause harmful interference to radio communications. However, there is no guarantee that interference will not occur in a particular installation. If this equipment does cause harmful interference to radio or television reception, which can be determined by turning the equipment off and on, the user is encouraged to try to correct the interference by one or more of the following measures:

- Reorient or relocate the receiving antenna.
- Increase the separation between the equipment and receiver.
- Connect the equipment into an outlet on a circuit different from that to which the receiver is connected.
- Consult the dealer or an experienced radio/TV technician for help.

## WARNING stickers

A number of WARNING stickers are affixed to the machine. Carefully observe the messages contained in the WARNING stickers, and use the machine safely. Do not remove any of the WARNING stickers. Do not damage or deface them. If any of the WARNING stickers are no longer in place, or have become difficult to read, please contact your sales dealer.

### Be careful so as to avoid pinching

While operating the machine, keep your fingers away from the frame.

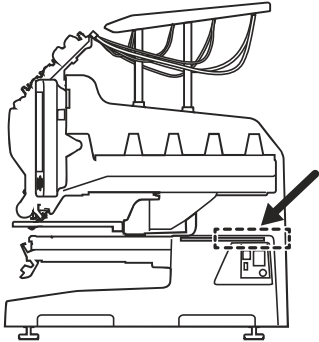

### Be careful with fingers

During operation, the rotary hook rotates at high speed, so keep your fingers away from it.

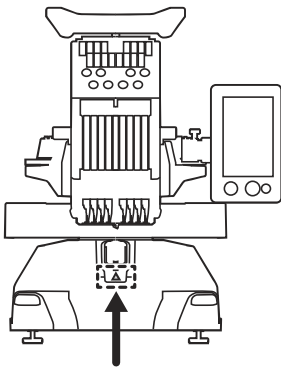

### Caution concerning laser

A Class 1 laser device is contained in the unit. Do not look directly at the laser beam.

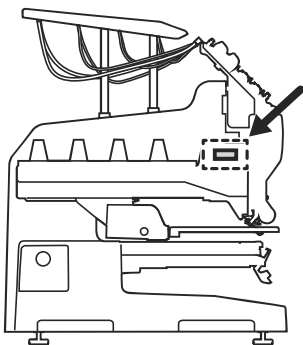

# Chapter 1 Let's Learn the Names of Things and What They Do

## 1.1 Machine main unit

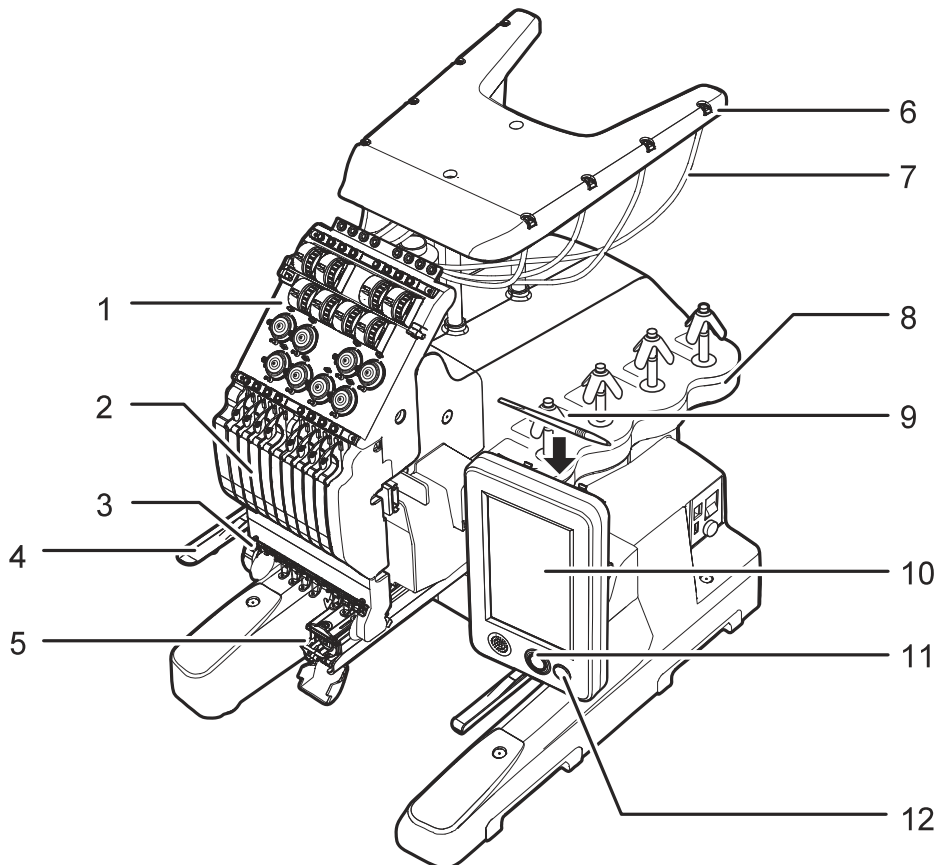

Number	Name	Function
1	Thread tension	Adjusts the tension of the upper thread.
2	Needle bar case	Slides to right and left; the selected needle moves to the embroidery position.
3	Needle base LED lamp	This LED illuminates the needle base.
4	Frame holder	Holds the tubular goods frame in place.
5	Bed/rotary hook	The machine is equipped with a rotary hook and thread cutting device. The under thread bobbin is placed on the rotary hook.
6	Thread course	Guides the upper thread.
7	Thread tube	Tube through which upper thread is passed.
8	Thread stand	Holds the upper thread.
9	Stylus	This stylus is designed for use with the touch panel.
10	Operation panel	This touch panel is used for operating the machine.
11	[START] button	Pressed to start embroidering.
12	[STOP] button	Pressed to stop embroidering.



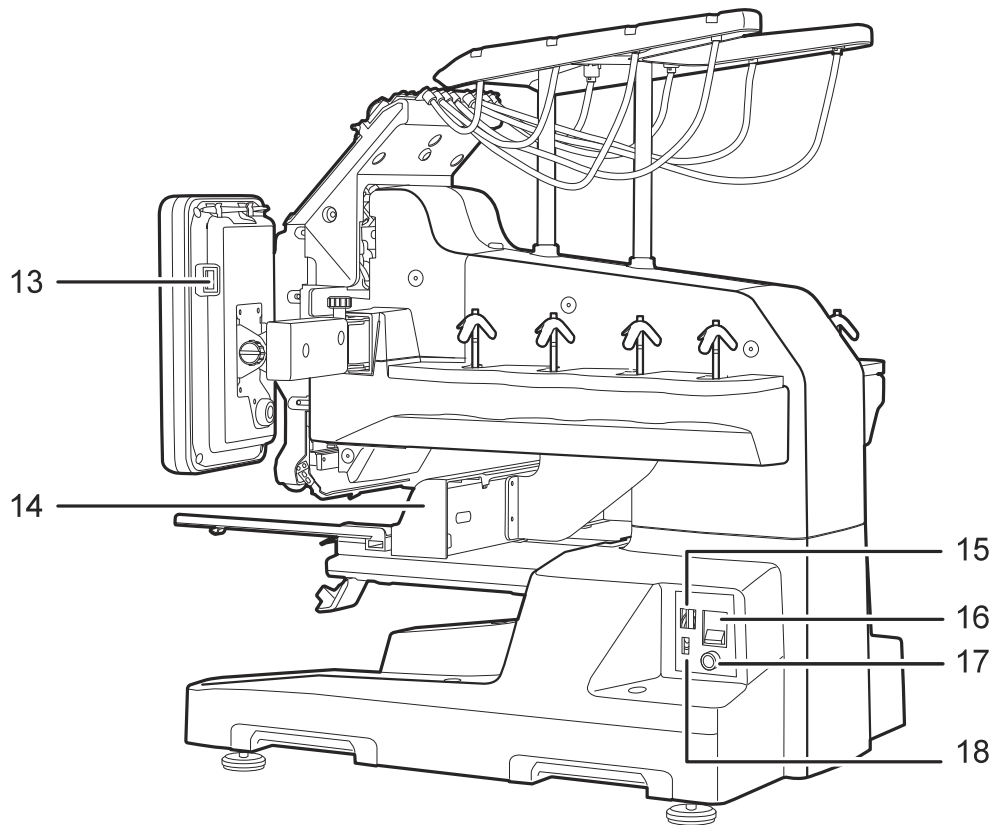

Number	Name	Function
13	USB port (*)	Used to connect a USB memory or barcode reader. Used mainly when connecting a USB memory.
14	Frame drive system	Moves the frame forward and back, and right and left.
15	LAN port	Used to connect a LAN cable.
16	Power switch	Switches power to the machine ON/OFF. [   ]: Power is on. [ O ]: Power is off.
17	Power inlet	Connect the connector of the AC adapter
18	USB port (*)	Used to connect a USB memory or barcode reader. Used mainly when connecting a barcode reader.

(\*) When a USB memory is connected, a second USB memory cannot be connected to the other USB port. The barcode reader can be connected simultaneously with a USB memory.

## 1.2 Home screen

After the power switch is turned ON, the following Home screen appears on the operation panel.

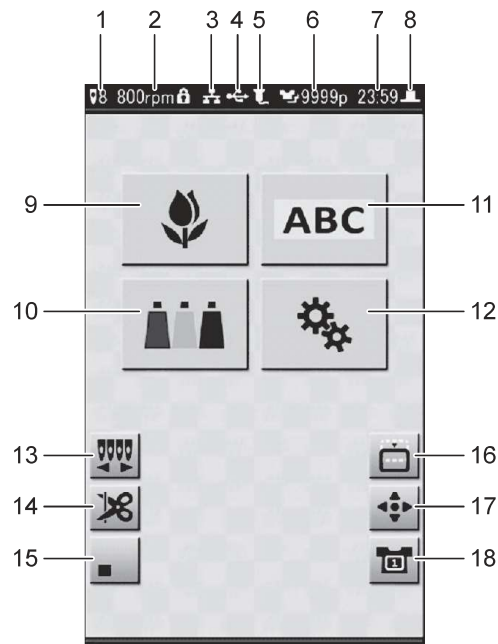

Number	Icon	Description
1		Current needle (No. 1 to 8) is displayed. is displayed while the laser crosshair marker is lit.
2		Indicates the sewing speed. The lock symbol is shown for design data that have speed limitations.
3		Shown when the network is set up.
4		Shown when a USB memory is connected to the machine.
5		Shown when a barcode reader is connected to the machine.
6		Displays the number of embroidered times for the current design data.
7		Displays the current time.
8		Shown when the main shaft of the machine has stopped at the normal position.
9		Selects a design data for embroidery.
10		Sets the thread colors.
11		Make the settings for lettering embroidery.
12		Make various settings for the machine.
13		Make manual color changes.
14		Cut thread manually.
15		Switches between display/hiding of icons.
16		Move the frame toward.
17		Manually move the frame.
18		Sets the type of frame.

## 1.3 Basic operations on the screens





The operation panel is a touch screen.

To switch among screens, make settings, etc., simply tap the icons displayed on the touch screen with your finger or the stylus packed with the machine.

There are a number of icons that are used in common throughout the various screens of the operation panel. Their purpose is the same on every panel.

When an icon is selected, or when a setting is ready to be changed, it is highlighted in yellow.

### ■ Icons Used in Common

Icon	Description
	Go back one screen
	Go to Home screen
	Confirm setting
	Go to next page
	Go to previous page

## Chapter 2 Getting Ready to Embroider

Before you start using the machine, prepare the needles, thread, and the fabric on which the embroidery is to be performed.

### 2.1 Replacing needles

Before you start embroidering, check the condition of the needles, and if any of them are bent or broken, replace them with new needles following the procedure below.

You will also need to change to needles appropriate for the type of fabric to be embroidered or the type of upper thread.

#### Caution

- ⊘ Always turn off the machine's power switch before you replace any needles.
- ⊘ If needles are not secured properly, the thread may break or the needles may bend or break, making it impossible to carry out embroidery correctly.

✎ Use needles designed to be used in embroidery machines. (Recommended: DB × K5Z1 [No. 9 through 14] made by ORGAN NEEDLE CO., LTD.) As standard, this machine comes with slightly thicker needles (DB × K5Z1 [No. 12]) preinstalled.

👉 For information on appropriate combinations of fabric, thread, and needles, see: "8.1 Producing beautiful embroidery".

1. While holding the needle, use the flat head screwdriver (2.5 × 75) to loosen the screw, and then remove the needle.

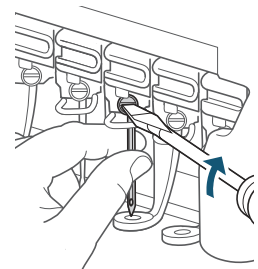

2. Insert a new needle all the way into the needle bar, until you feel it make contact.
3. Position the needle so its groove faces forward, then tighten the screw to secure it.

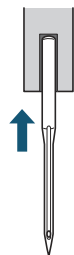

## 2.2 Threading the upper thread

The following illustration shows the places through which the upper threads for each needle should be passed. Carefully thread each upper thread, making sure that its path is correct at each position. The numbers that appear in the illustration below correspond to the needle numbers.

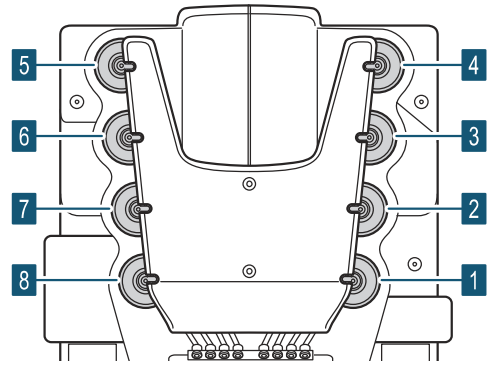
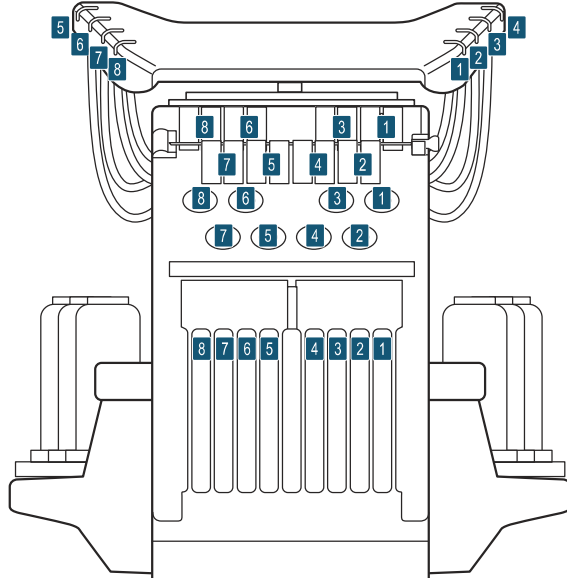

1. Place the spools of thread on the thread stand.



When using a thread cone with a small hole, remove the thread stand blade.

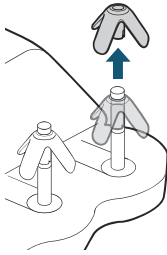

2. Lift up the thread pressing shaft.

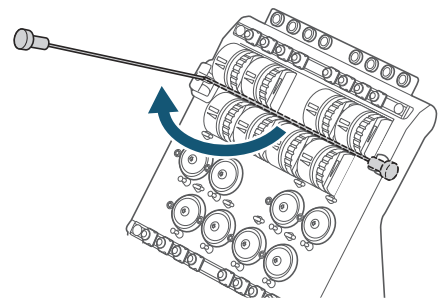

- 3. Hook the upper thread onto the tip of the upper thread guide (Accessory part), and insert it into the thread tube.**

Continue inserting until the threader comes out from the thread tube opening that is fixed in the tension base.

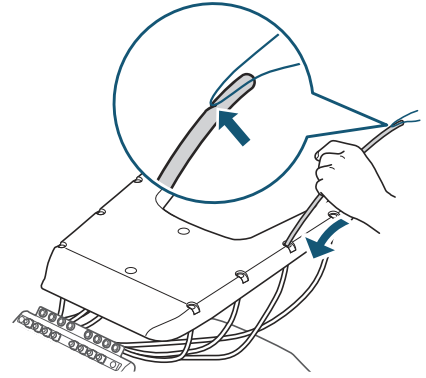

- 4. Once the upper thread has through the thread tube opening, thread it as shown in the illustration to the right.**

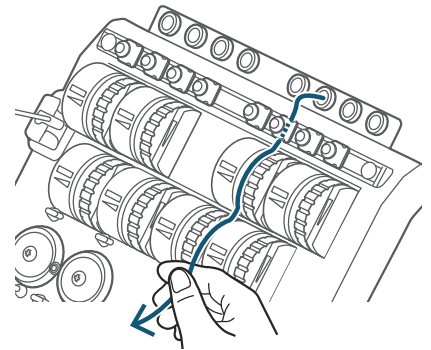

- 5. As illustrated to the right, pass the upper thread through the thread guide, and then pass it around the thread breakage detection disk.**



An arrow, which shows the direction in which the upper thread should travel, is imprinted around the thread breakage detection disk. Follow this arrow when threading the upper thread.

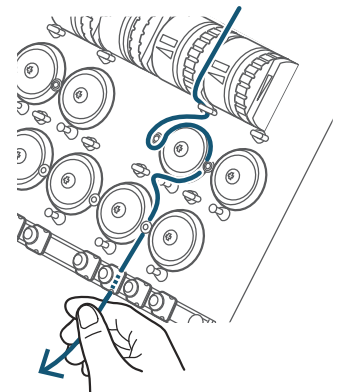

- 6.** As illustrated to the right, place the upper thread on the center thread course of the needle bar case, and then thread it through the hole at the top.

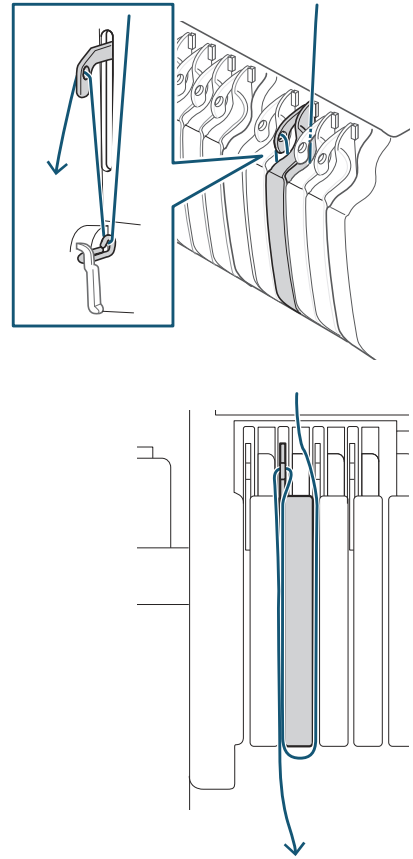
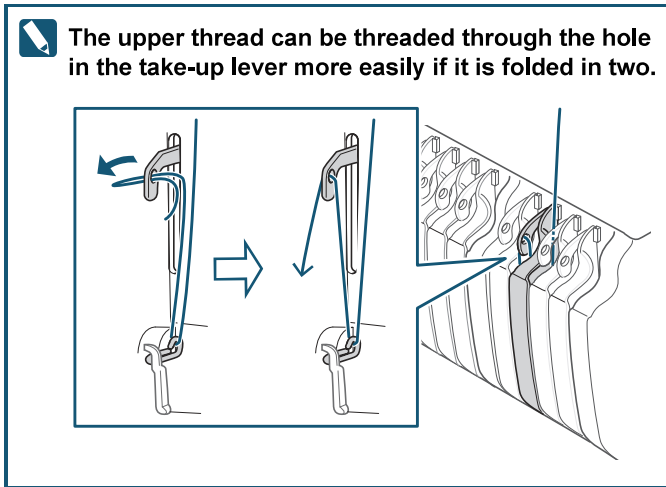

- 7.** As illustrated to the right, thread the upper thread through the needle eye.

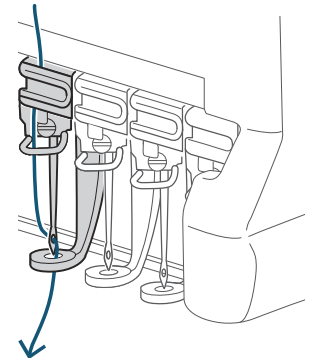
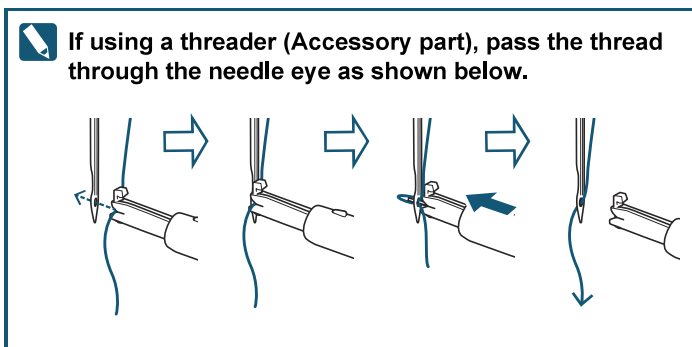

- 8.** Replace the thread pressing shaft and press it down until it clicks into place.

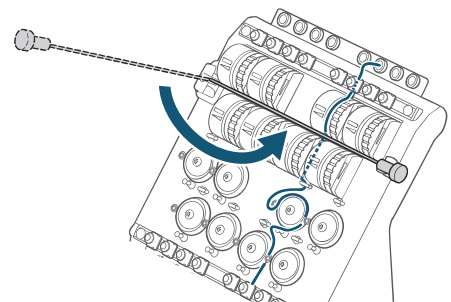

### ■ Using spool nets

When using metallic threads (gold or silver threads) or threads with high tensile strength, spool nets (Accessory part) should be placed over the spools. By using spool nets, you can help prevent thread snarling. If the spool net is too long, fold it back so it is better matched to the size of the spool.

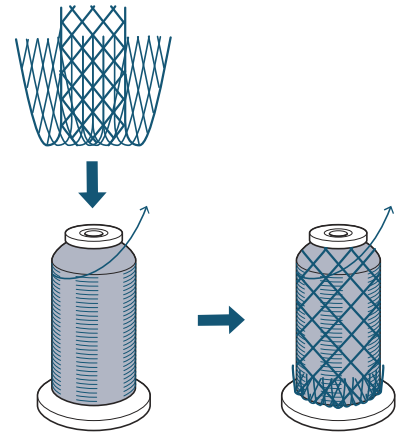



## 2.3 Setting the under thread

Initially, only the bobbin case is installed in the rotary hook and you will need to install a bobbin before running the machine. First, take the bobbin case out of the rotary hook. Then, after winding the under thread onto the bobbin, place it in the bobbin case.

### Caution

 Make sure to turn off the power switch before you take out or insert the bobbin case.

### 2.3.1 Removing the bobbin case

1. Open the front cover of the bed.
2. While holding the latch lever of the bobbin case, remove the bobbin case from the rotary hook.

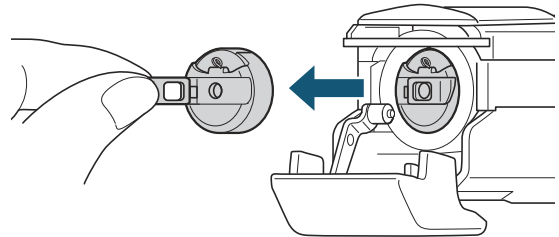

### 2.3.2 Putting the bobbin in place

1. While positioning the bobbin so its thread winding direction is clockwise, insert it into the bobbin case, from the right side.

 If the thread winding direction is reversed, abnormalities in the sewing will occur.

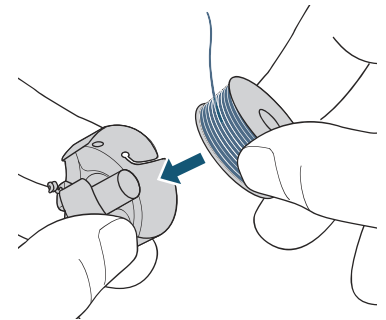

2. Holding the end of the thread, guide the under thread through the slit (1) in the bobbin case.

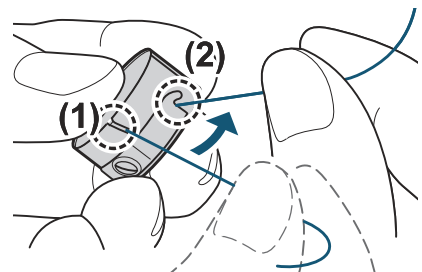

3. Guide the under thread to the spring edge (2).

**4. Adjust the tension of the under thread.**

Suspend the bobbin case by holding the end of the thread, and swing it back and forth. If the under thread comes out slowly, it means that the tension is set to the appropriate amount.

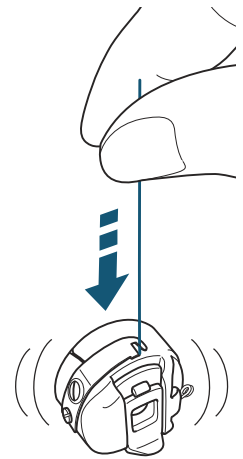

If an adjustment is necessary, turn the thread tension adjustment screw using the bobbin-case-use flat head screwdriver.

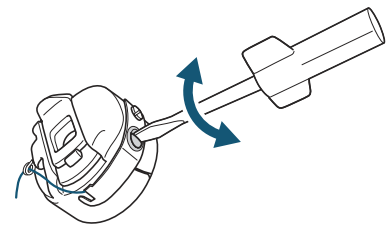
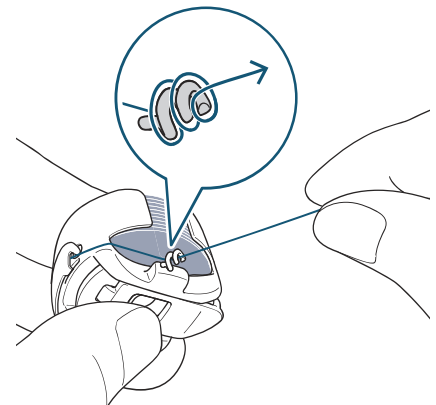
**5. Wrap the under thread twice around the thread guide coil.****2.3.3 Placing in rotary hook**

- 1. Pull out about 5 cm length of under thread from the bobbin case.**
- 2. Place the bobbin case inside the rotary hook and listen for it to click.**



Let the under thread hang loosely in front of the bobbin case.

### 3. Close the front cover of the bed.

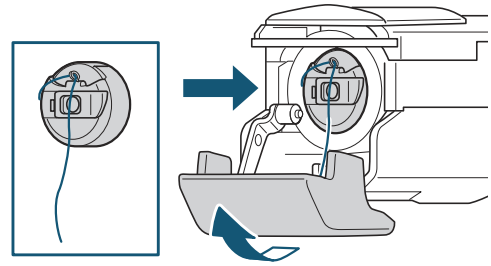

## 2.4 Setting up the embroidery frame

There are two sizes of embroidery frames available, one large, one small. Select the appropriate one to use depending on the size of the design.

Note that you must change the settings for the frame on the operation panel whenever you change the embroidery frame.

At the default setting, the machine is set to use [Tubular 1] (large embroidery frame providing an embroidery area that has length of 200 mm and a width of 300 mm).

👉 "6.2 Frame settings"

### 2.4.1 Mounting the fabric on the embroidery frame

In order to ensure that the embroidery finish will look good, it is important to correctly stretch out the fabric over the embroidery frame.

To carry out this work, the embroidery frame should be placed on a table or other level surface.

#### 1. Loosen the adjustment screw on the outer frame.

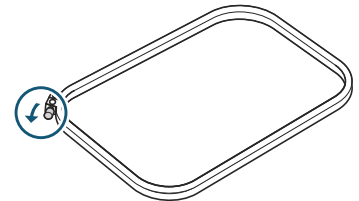

#### 2. Position the fabric on top of the outer frame.

 With highly stretchable fabrics, such as those used for T-shirts and knits, backing or plastic material should be spread out underneath the fabric before mounting it on the frame.

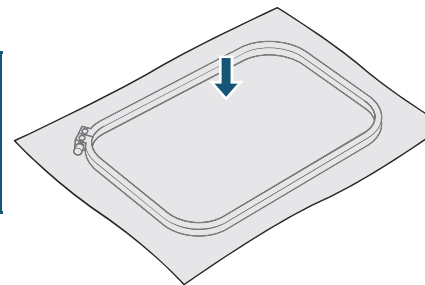

#### 3. Place the inner frame and push it in.

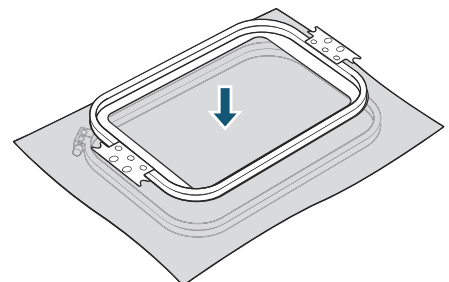

- 4.** Loosely tighten the adjustment screw on the outer frame, and then smooth out the cloth within the frame to remove any looseness or wrinkles.



Stretch out the fabric only to the extent that none of its weave is disturbed in any way.

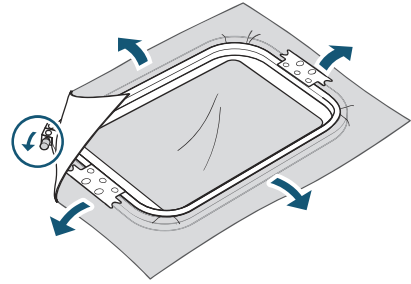

- 5.** Tighten the adjustment screw on the outer frame.

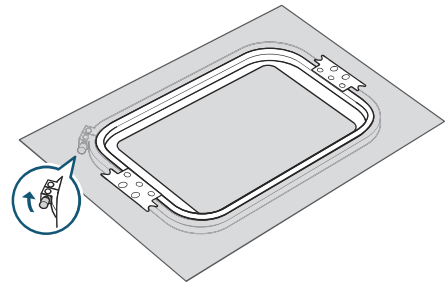

### 2.4.2 Attaching an embroidery frame

- 1.** Pick up the embroidery frame, and hold it so the inner frame is visible and faces upwards.
- 2.** Push in the frame so that the arms on the right and left sides of the frame are engaged with the clips of the frame holder.

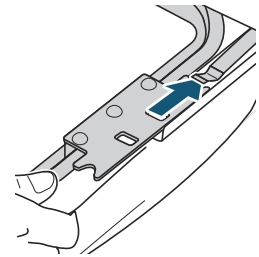

- 3.** Push the embroidery frame in until the front edges of the frame holder's fixtures click into place in the holes at the front of the attachment arm.

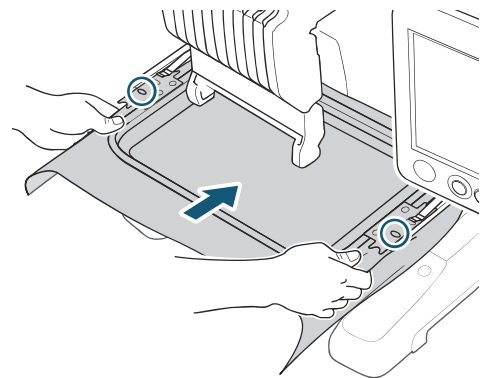

# Chapter 3 How to Perform Embroidery

In the following we will explain the steps you need to take to perform embroidery from start to finish. First, get needles, thread, and fabric ready. Then, follow along with this manual and perform the actual operations. That way, you should be able to easily learn the basic things you need to do to use the machine.

3

## 3.1 Turning on the power

1. Insert the power plug of the AC adapter into the outlet.
2. Turn on the machine's power switch.

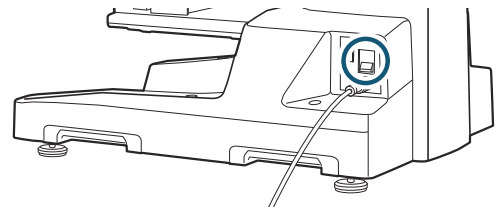

The machine starts up, and the Home screen is displayed on the operation panel.

Also, the [START] and [STOP] button on the operation panel will light up.

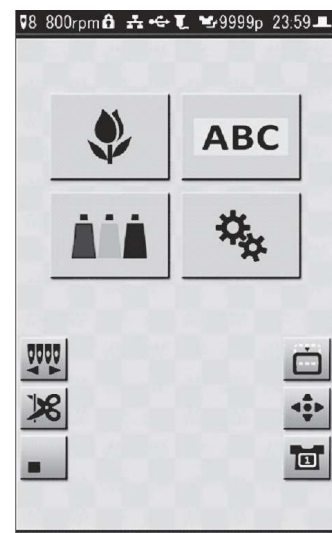

Initially, it is set so that a confirmation screen prompting you to store the frame origin is displayed before the Home screen is displayed. Tap **YES** to memorize the frame origin.

### Caution

- ⊘ Keep hands away from the area surrounding the frame and needle bar case while the frame origin is being memorized. Always wait until the next screen is displayed. Otherwise, there is a risk of injury due to the movement of the frame and needle bar case.

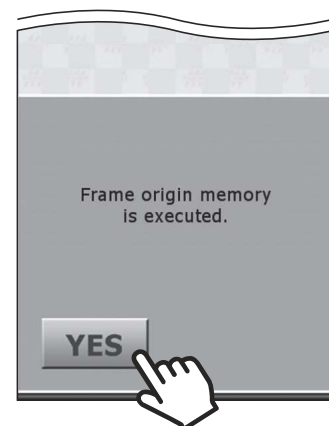

If an embroidery has been paused midway through, and the power has been cycled, the Paused screen is displayed instead of the Home screen.

3



## 3.2 Starting the embroidery

In the following, we will explain the steps you need to take before performing an embroidery.

### 3.2.1 Loading the design to be embroidered

Using any of the following methods, load the design to be embroidered.

- Load from USB memory (USB flash drive)
- Load from Record/Favorite
- Load from PC via LAN



Here, we will explain how a design can be loaded from a USB memory (USB flash drive).

 For other ways of loading designs: "4.3 Loading designs from records or favorites", "4.4 Loading a design from a PC using a LAN cable"

1. **Connect the USB memory (USB flash drive) to the USB port on the side of the operation panel.**



 Use USB 2.0 compatible devices formatted in the FAT/FAT32 file system.

#### Caution

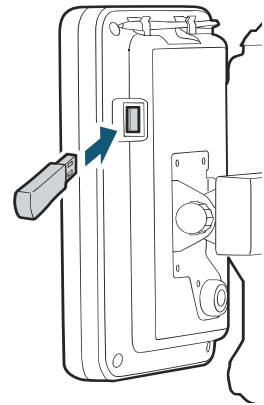
-  Be aware that some USB memory (USB flash drive) cannot be used due to slight differences in specifications.
-  Never remove a USB memory (USB flash drive) while designs are being read from it. Failure to observe this could result in damage to the USB memory (USB flash drive) or to the internal data of the machine.



2. Tap  on the Home screen. The Design Load screen is displayed.

3. Tap  USB. Folders and designs are displayed in the Design List screen. Tap  to switch pages.



#### 4. Tap a folder to select designs that are contained in the folder.

The root folder and three levels of subfolders of the USB memory (USB flash drive) are loaded. Up to 255 designs contained in a folder can be displayed in the List screen.

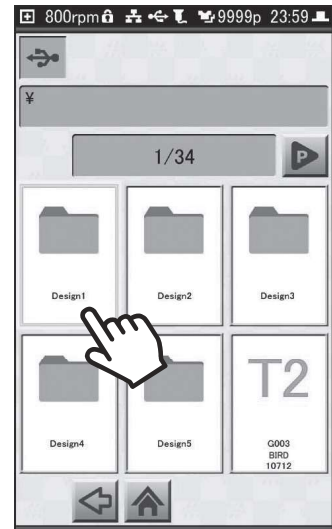
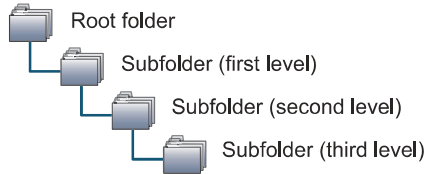

The design-load source is displayed in the upper-left corner of the screen.

USB memory (USB flash drive) / LAN / Record /Favorite

#### 5. Tap the design to be embroidered.

Reduced-size images (thumbnails) of designs that have been loaded from Record or Favorite, or from a PC via the LAN are displayed in the design list.

An icon labeled with one of the following data types is shown in the design list for designs that have been loaded from USB memory (USB flash drive).

- T: DST format
- T2: TBF format
- T3: TCF format
- B: DSB format
- Z: DSZ format
- U: U code format

When a design is loaded from USB memory (USB flash drive), a reduced-size image (thumbnail) of the design is displayed after the design is selected.

#### 6. Tap .

The selected design is loaded, and the Needle No. Setting screen is displayed.

An error screen (225) is displayed if the size of the design is too large, and exceeds the range within which embroidery can be carried out. In such cases, tap [RESET], and change the design to one which will fit within the range that can be embroidered. Also, check to make sure that the frame type is correct.

"6.2 Frame settings"



### 3.2.2 Setting the needle number

With some designs, the thread color and needle number for each step (order, for each color, in which embroidery is to take place) are already assigned in the design. Even without changing the settings for steps, for each step in the design, the upper thread of the color that you want to embroider can be set for the set needle No., allowing embroidery to take place using the correct color order.

Also, even if steps are stored in the design, the needle number of the upper thread actually used in the embroidery can be changed. Additionally, when you want to use a design that has no steps assigned to it, you can set the appropriate needle numbers and then carry out embroidery.

Here, we will explain the procedure for changing the needle No. of a step.

 If a design that does not have steps assigned within it is loaded, all of the steps from needle No. 1 to No. 8 are assigned, in order.

 For details on setting steps: "4.6 Editing the steps of a design"

1. On the Needle No. Setting screen, tap the icon for the first step.

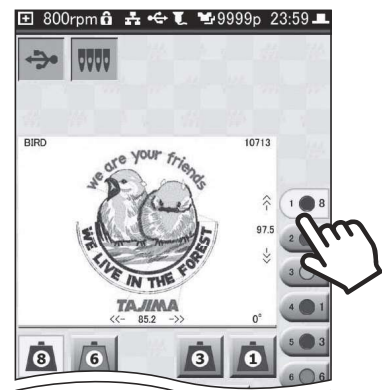

2. Tap the needle No. (1 to 8) that has the thread of the color that you want to assign to step 1.

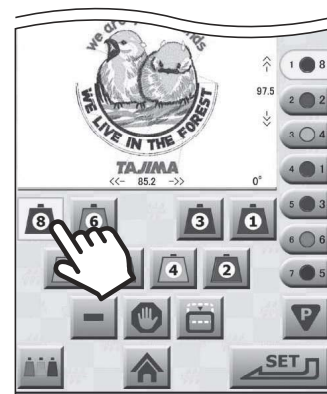

3. Repeat steps 1 and 2 until all steps have a needle number assigned to them.





4. Tap .

The Start Point Setting screen is displayed.



### 3.2.3 Setting the orientation of the design and the start point

Here's how to set the orientation of the design and the embroidery start point.

#### 1. Select the orientation of the design.

- To leave it in the original position: 
- To rotate it 90° clockwise: 
- To rotate it 90° counterclockwise: 
- To rotate it 180°: 

The preview of the design display and the tulip rotate to reflect the direction of rotation angle that was selected.

 When embroidering a cap (as a finished product) using cap frame, select  (180°). This is because, when using a cap, it is mounted upside down on the machine. When you are using a design that has already been rotated, there's no need to change the orientation of the design.

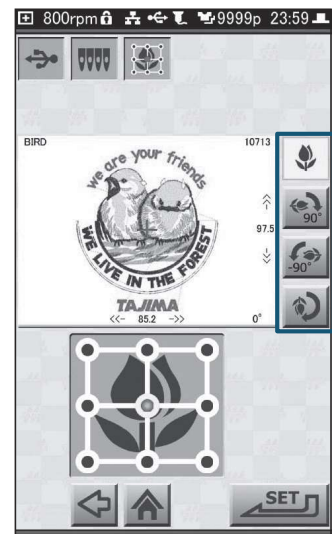

#### 2. Tap the position for starting the embroidery from among the 9 points indicated in the design preview.

The specified position is displayed in red.

 You should try to select a place for the start position that allows for easy alignment of the frame.

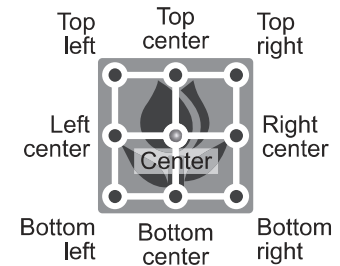

#### 3. Tap .

The Frame Position Setting screen is displayed.

### 3.2.4 Moving the frame to the embroidery start point

Manually, move the frame to the embroidery start point.



#### Caution

 Keep hands away from the area surrounding the frame. Otherwise, there is a risk of injury due to the movement of the frame.

 If you turn on the laser crosshair marker beforehand, you can easily see the place where the needle is going to fall. This makes it easier to determine the start point of the design.

 "4.11 Using the laser crosshair marker"

- Using the frame travel keys , move the frame to the embroidery start position. Tap the arrow icons you need to move the frame in the desired direction.

 With each press of the center button of the frame travel keys , the speed of frame movement is toggled between high speed and low speed. Also, the color of the button changes as follows.

- High-speed: green
- Low-speed: gray

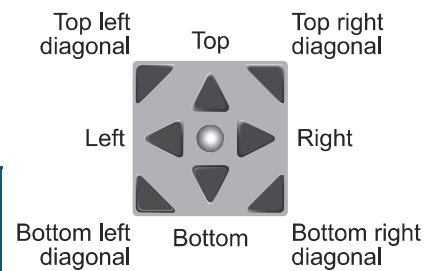

- Once the start point for the embroidery has been determined, tap .

The Trace screen is displayed.

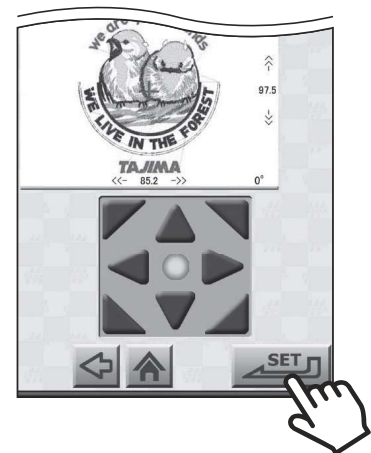

### 3.2.5 Confirming that the design fits within the embroidery area

By using the trace function, which moves the frame in accordance with the contour of the design, you can find out whether the embroidery design is appropriate or not, and whether the allowable area for embroidery will be exceeded or not.

#### Caution

- ⊘ Keep hands away from the area surrounding the frame and needle bar case while the trace is being carried out. Otherwise, there is a risk of injury due to the movement of the frame and needle bar case.

#### 1. Tap on the Trace screen.

The confirmation screen is displayed.

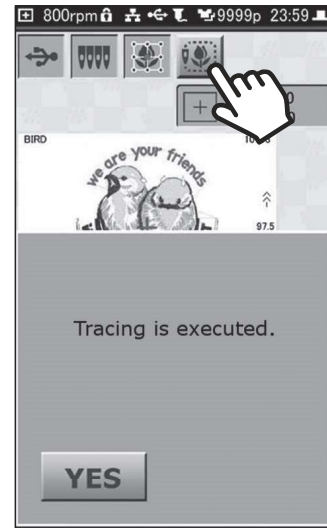



#### 2. Tap [YES].

The laser crosshair marker lights, the frame moves in accordance with the contour of the design, and traces the path shown to the right.



While the trace is in progress, an hourglass is displayed on the screen. This indication disappears when the trace is completed.

- ✎ If the needle position is not at the position of the laser crosshair marker before the trace is started, the needle position moves to the position of the laser crosshair marker first, and after that, the trace starts.
- ✎ If you want to change the embroidery position, use the  icon to display the frame travel keys, and then move the frame.
- ✎ To pause a trace while it is in progress, press the [STOP] button on the operation panel. To continue the trace, tap [YES] in the confirmation screen; to cancel it, tap [NO].
- ✎ If the design will not fit in the frame, an error screen (225) is displayed. Tap [RESET], and use the  icon to display the frame travel keys, and then move the frame.



3. If you have determined, as the result of the trace, that there are no problems with the embroidery position, tap .

The Embroidery Start screen is displayed.

 If a start message has been set for the design, the start message screen is displayed.

### 3.2.6 Selecting the speed

Three speeds are available: high speed, medium speed, and low speed. Select the speed that you would like to use.

-  The default setting is [H] (800 rpm)
-  The speed can also be changed when the machine is paused while an embroidery is in progress.
-  If a start message has been set for the design, tap [RESET] to close the start message screen. After that, perform the operation.

1. Tap  on the Embroidery Start screen.

The Speed Setting screen is displayed.

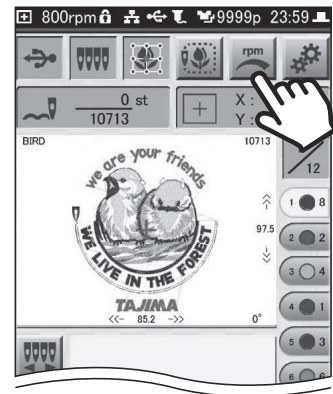

2. Select either [H], [M], or [L] as the speed.

- To embroider at high speed, 800 rpm: [H]
- To embroider at medium speed, 500 rpm: [M]
- To embroider at low speed, 250 rpm: [L]

 A general estimate of the amount of time it will take to complete the embroidery is shown for each speed button.

3. Tap .

You will be returned to the Embroidery Start screen.

### 3.2.7 Starting the embroidery

The following explains each item on the Embroidery Start screen.

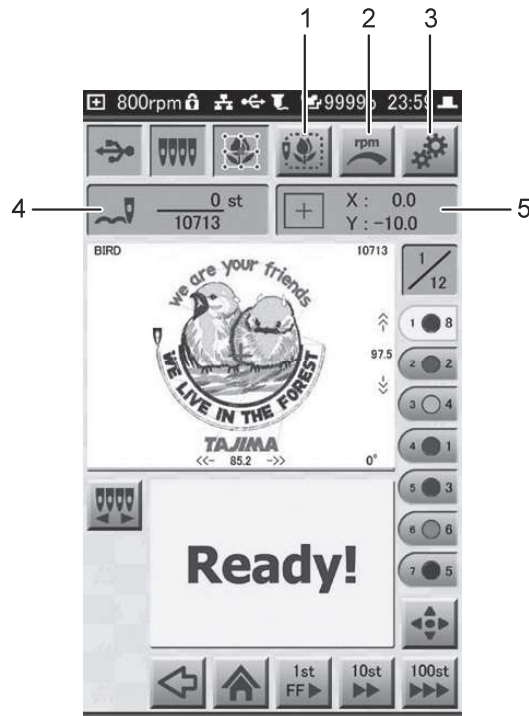

Number	Icon	Description
1		Opens the Trace screen. ☞ "3.2.5 Confirming that the design fits within the embroidery area"
2		Opens the Sewing Speed Setting screen. ☞ "3.2.6 Selecting the speed"
3		Opens the Setting screen. Tap  on the Setting screen, and the Embroidery Setting screen is displayed. ☞ "6.1 Adjusting the embroidery settings" Tap  on the Setting screen, and the Info/Maintenance Setting screen is displayed. ☞ "6.5 Setting the language used for display on the operation panel", "6.6 Displaying information about the machine"
4		The number of stitches in the design is displayed as the sewn design stitch count and the total stitch count.
5		The current frame coordinates are displayed. To display frame coordinates correctly, the frame origin needs to be stored in memory. ☞ "6.2.2 Memorizing the frame origin"

#### Caution

⚠ Keep hands away from the area surrounding the frame while embroidery is in progress. Otherwise, there is a risk of injury due to the movement of the frame.

1. While the Embroidery Start screen is displayed, press the [START] button on the operation panel.

The embroidery starts.

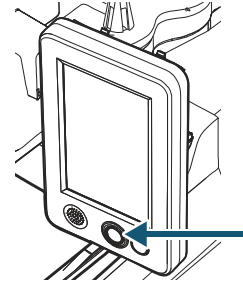

An image of the design is displayed on the operation panel, and the current position of the needle is indicated with a marker. Also, areas where embroidery has been completed are shown in gray.

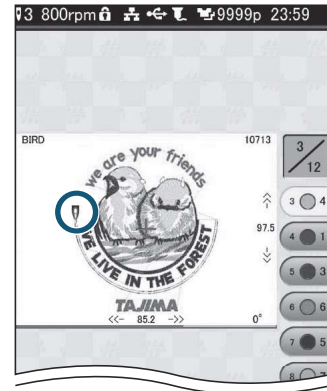

When the embroidery is finished, the Embroidery Complete screen is displayed.

2. To finish with the embroidery, tap [NO]. To embroider the same design again, tap [YES].

If you tapped [YES], the Embroidery Start screen is displayed.

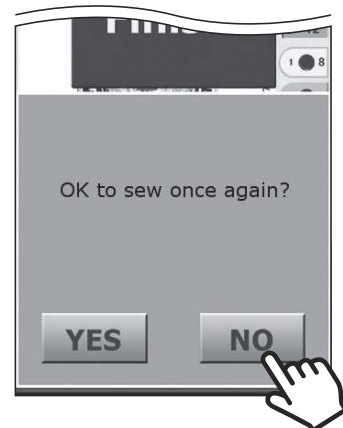

### 3.2.8 Pausing the machine

While embroidery is in progress, the machine can be paused.

1. Press the [STOP] button on the operation panel while embroidery is in progress.

The machine stops and the Paused screen is displayed.

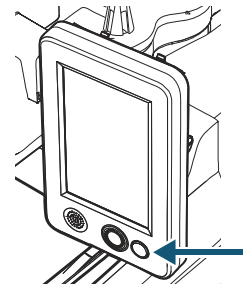

The following explains items not displayed on the Embroidery Start screen.



Number	Icon	Description
1		Thread is trimmed automatically, and embroidery is stopped. Returns to the Embroidery Start screen.
2		Opens the Needle No. Setting screen. 👉 "4.6 Editing the steps of a design"
3		Thread is trimmed automatically, and embroidery is stopped. Returns to the Home screen.
4		The needle bar case moves to the position of the laser crosshair marker and the laser crosshair marker lights.



### ■ Resuming embroidery

Press the [START] button on the operation panel.  
Embroidery resumes from the paused position.

### ■ Starting the embroidery again from the beginning

Tap , and then tap [YES].

Thread is trimmed automatically, and embroidery is stopped. Also, you are returned to the Embroidery Start screen.



### ■ Ending the embroidery

Tap , and then tap [YES].

Thread is trimmed automatically, and embroidery is stopped. And, you are returned to the Home screen.

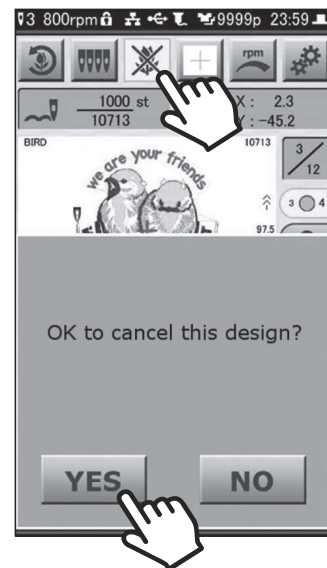

### 3.2.9 When thread breaks during embroidery

When thread breakage is detected, the machine stops automatically and an error is displayed. You should deal with this in the following methods, depending on the content of the error.

#### ■ When "Upper Thread Break" (291) is displayed.

Re-thread the upper thread through the needle.

#### ■ When "Bobbin Thread Break" (293) is displayed.

Take the bobbin case out of the rotary hook, and check the condition of the under thread.



If the under thread is not threaded properly in the bobbin case, correct this by re-threading it.

Also, if there is no longer any bobbin thread, or if there isn't much thread left, replace the bobbin.

#### "2.3 Setting the under thread"

Once the thread breakage issue has been dealt with, press the [START] button on the operation panel. Embroidery will resume.



Repair stitching can be carried out at the place where the thread broke by reversing/advancing the frame using  and  at the bottom of the Paused screen.

 "4.9 Returning frame/advancing frame according to design"

## 3.3 Ending the embroidery

### 3.3.1 Removing the frame and fabric

1. While lifting the front of the frame, remove the frame from the machine's frame holder.
2. Disengage the clips on the inner frame.
3. Take away the fabric.

### 3.3.2 Checking the tension of the upper thread

If the under thread is appearing on the front of the fabric, you should lower the thread tension of the upper thread. Also, if the tightness of the upper thread stitching is deficient, you should raise the thread tension.

Refer to the following illustration, which shows a view of the fabric from the side, and check that the thread tension is appropriate.

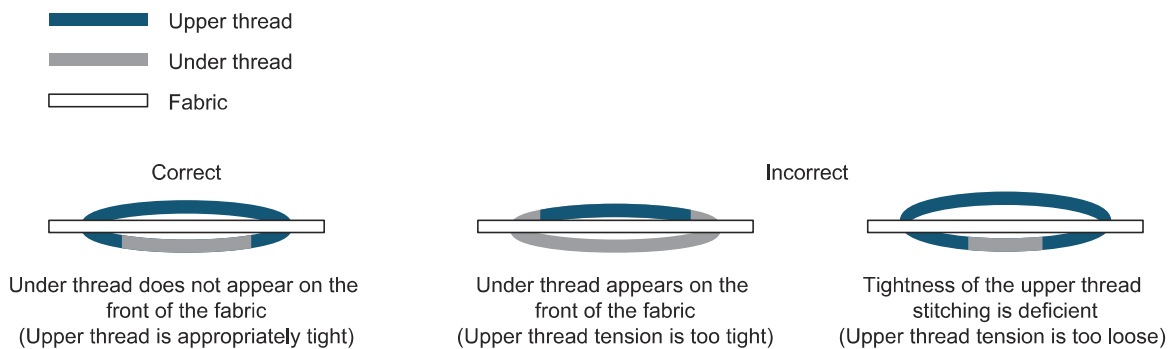

The upper thread tension is raised by turning the thread tension dial upwards. To lower the tension of the upper thread, turn the dial down.

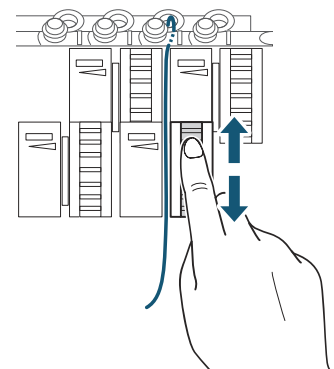

 To check the tension of the upper thread, the thread lock needs to be in the raised position as shown below. It cannot be checked properly if the thread lock is not raised.

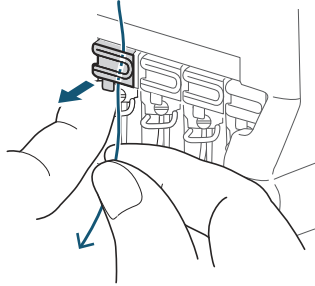

### 3.3.3 Turning off the machine's power

1. Turn off the machine's power switch.
2. Pull out the power plug from the outlet.

#### Caution

 When you need to cycle power to the machine, turn off the power, wait at least 5 seconds or more, then turn it back on.

# Chapter 4 Getting the Most Out of the Machine

Your machine offers a variety of convenient functions. For example, you can easily search for designs that have been used before, you can set the order in which a design is to be sewn, and you can carry out repair sewing.

## 4.1 Hiding icons in the Home screen

4

Here's how to set the machine so only the wallpaper is shown in its display. This setting can be conveniently used to prevent inadvertent operations.

**1. Tap  on the Home screen.**

The Home screen is no longer displayed, and  is displayed.

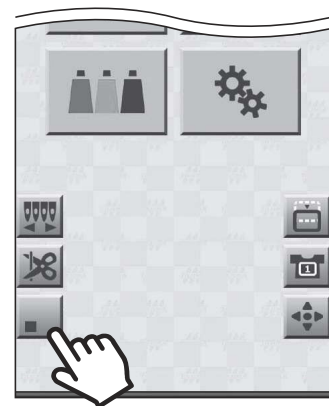

**2. To return to the original display, tap .**

The Home screen is displayed.

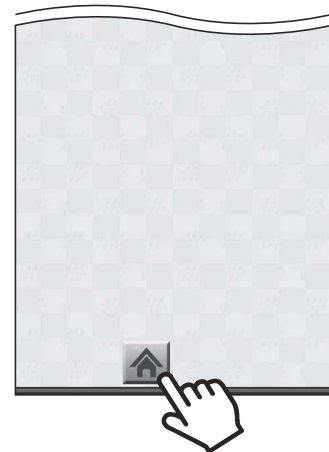

## 4.2 Storing a design as a favorite or removing it

From the Record screen, designs you've used before can be stored in the Record.

By storing a design that you use frequently, it can conveniently be called up the next time you want to use it.

### How to store a design as a favorite

1. Tap  on the Home screen.  
The Design Load screen is displayed.

2. Tap  Record .  
The Design List screen is displayed.

 is displayed only when the Record contains something. It is not displayed when embroidering for the first time.



3. Select the design you want to store in the favorites, and then tap .



The selected design is stored in the favorites, and  is displayed in the lower left corner of the design.



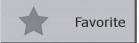

## ■ Removing a design from the favorites

1. Tap  or  on the Design Load screen.

The Design List screen is displayed.

2. Tap the design you want to remove from the favorites.

The  displayed at the lower left corner of the screen changes to .



3. Tap .

The confirmation screen is displayed.

4. Tap [YES].

The selected design is removed from the favorites, and the  in the lower left corner of the design disappears.

If  is tapped while in the Favorite List screen, the design disappears from the List screen.





## 4.3 Loading designs from records or favorites

Designs that have been loaded before, and designs that have been stored in the favorites can be selected from Record or Favorite, and then used to perform embroidery.

 Once a design has been loaded, it is stored in Record. Up to 200 designs can be stored in Record. If the 200 design limit is exceeded, designs will be erased, with the oldest being erased first.

1. Tap  on the Home screen.  
The Design Load screen is displayed.

2. Tap  Record or  Favorite .  
The Design List screen is displayed.

  Record is displayed only when the Record contains something. It is not displayed when embroidering for the first time.

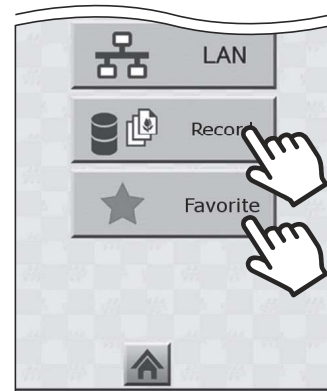



3. Select the design to be embroidered, and then tap .

The selected design is loaded, and the Needle No. Setting screen is displayed.

Next, you should perform the steps that need to be carried out before you can start an embroidery, such as setting the needle numbers and the embroidery start point.

 "3.2.2 Setting the needle number" and related sections thereafter

 When a design is loaded from Record, a confirmation screen is displayed if the thread colors of the design are different from the current thread color settings. Tap [RESET], and then change the thread color settings as necessary.



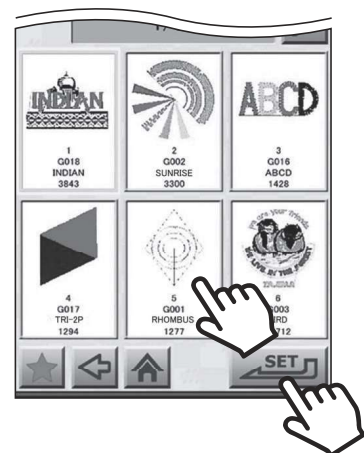

 "4.7 Setting the thread colors"







## 4.4 Loading a design from a PC using a LAN cable

Designs from the dedicated design creation software or a separately available DG product on a PC can be loaded into the machine after it has been connected to the PC using a LAN cable.

-  If you want to directly connect the PC to the machine, you will need to prepare a commercially available cross-cable.
-  If connecting the machine to a network (router or hub), prepare a commercially available straight cable.
-  Network information for the machine needs to be set beforehand.  
 "6.3 Performing network settings"

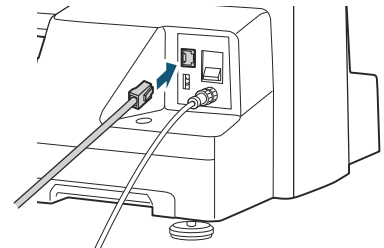
1. Turn off the machine's power switch.
2. Connect the LAN cable to the PC's LAN port, or to the LAN port on the router or hub.
3. Connect the LAN cable to the LAN port on the right side of the machine.



4. Start up the PC, and then start up the design creation software.
5. Turn on the machine's power switch.
6. Tap  on the Home screen.  
The Design Load screen is displayed.

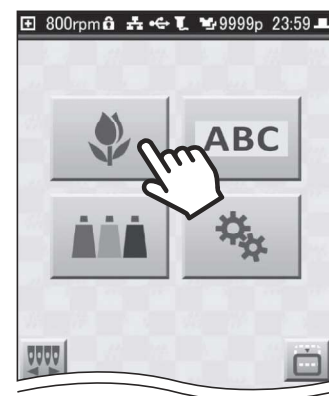

7. Using the design creation software, send the design to the machine.

 For information on how to use the design creation software, refer to the manual for the design creation software.

## 8. Tap LAN.

The Design List screen is displayed, select the design to be loaded.

Next, perform the steps that need to be carried out before you can start embroidery, such as setting the needle numbers and the embroidery start point.

☞ "3.2.2 Setting the needle number" and related sections thereafter

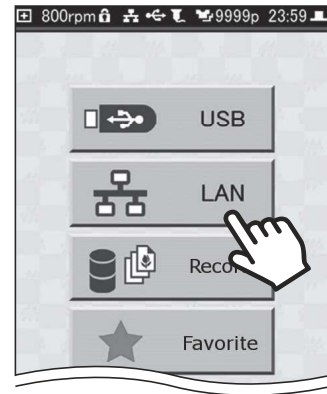

## 4.5 Loading a design using a barcode reader

Bar codes for designs, which have been printed using the dedicated design creation software or a separate DG product, can be read using a commercially available bar code reader and loaded into the machine.

### Caution

⊘ To use a bar code reader, the dedicated design creation software or a separately available DG product is necessary. The PC needs to be connected to the machine using a LAN cable, and the network information for the machine needs to be set beforehand.

☞ "4.4 Loading a design from a PC using a LAN cable", "6.3 Performing network settings"

⊘ Only bar code readers that are compatible with CODE 39 can be used.

⊘ Make sure that only single-byte alphanumeric characters are used in the names of files to be read using a barcode reader. Note that all alphabetic characters in the file name will be converted to uppercase letters.

1. Connect the USB cable of the barcode reader to the USB port on the right side of the machine.

2. Send the design to the machine using the design creation software, and then print the bar code.

☞ For information on how to use the design creation software, refer to the manual for the design creation software.

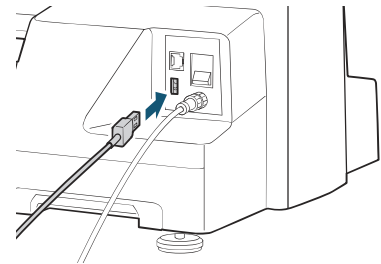

3. Use a barcode reader to read the barcode that was printed in step 2.

The design is loaded, and the Start Point Setting screen is displayed.

Next, you should perform the other steps that need to be carried out before you can start an embroidery, such as deciding on the orientation of the design and setting the embroidery start point.

☞ "3.2.3 Setting the orientation of the design and the start point" and related sections thereafter

## 4.6 Editing the steps of a design

With some designs, the thread color and needle number for each step (order, for each color, in which sewing is to take place) are already assigned to the design. The following explains the steps you need to take if you want to carry out embroidery using needle numbers different than those stored within the design.

The steps below should also be followed when you want to set the appropriate needle numbers for a design that did not have any steps assigned within it, and then perform embroidery.

Any of the following operations can be inserted between steps:

- Bring frame out
- Pause embroidery
- Repeat step

 If you want to use the color information that is already stored, the procedures explained here are unnecessary.

### 1. Tap on the Home screen.

The Design Load screen is displayed.

### 2. Tap the source from which you want to load a design, and then load the design.

The Needle No. Setting screen is displayed.

 If a design that does not have steps assigned within it is loaded, all of the steps from needle No. 1 to No. 8 are assigned, in order.

 "3.2.1 Loading the design to be embroidered", "4.3 Loading designs from records or favorites", "4.4 Loading a design from a PC using a LAN cable"



### 4.6.1 Needle No. Setting screen

4

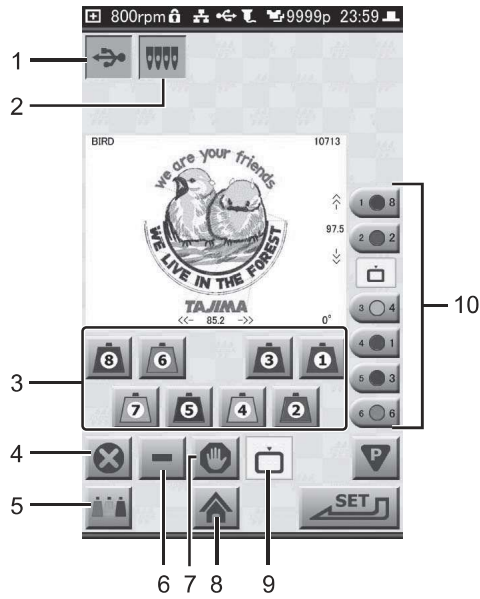

Number	Icon	Description
1		Displays the design-load source.
2		Displayed while setting thread colors and steps. If you've arrived at this screen from the Pause screen, this icon is not displayed.
3		Displays the thread color and needle No.
4		Removes the inserted operation.
5		Displays the Thread Color Setting screen.
6		Inserts a step repetition operation.
7		Inserts a pause operation.
8		Returns to the Home screen.
9		Inserts a bring frame out operation.
10		Displays the embroidery's step number, thread color, and needle No.

\* The content displayed for each part is as follows:

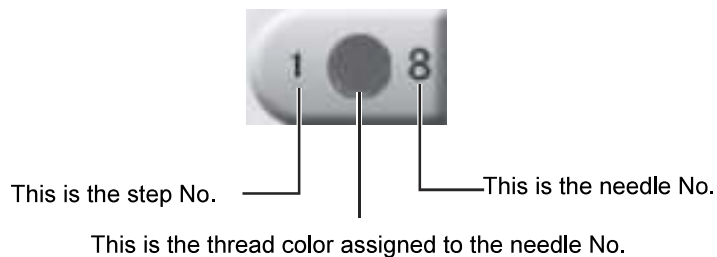

## 4.6.2 Setting the needle number

1. In the Needle No. Setting screen, tap the icon for the step for which you want to set the needle No.

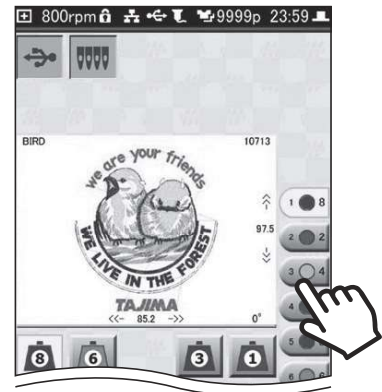

The icon of the step that was tapped and the needle No. set for the step are highlighted in yellow.

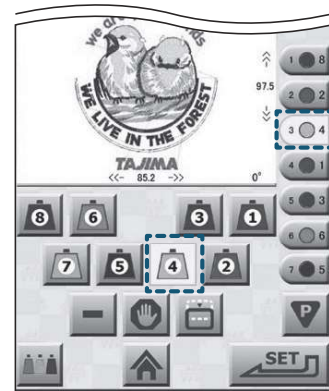

2. Tap the needle No. (1 to 8) that carries the color of thread that you want to set for the step.

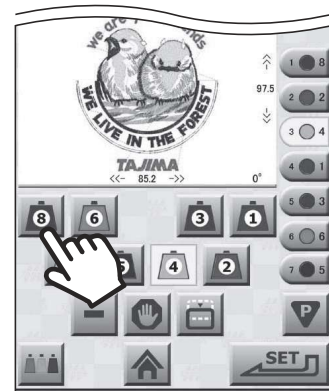

The needle No. is set to the step.

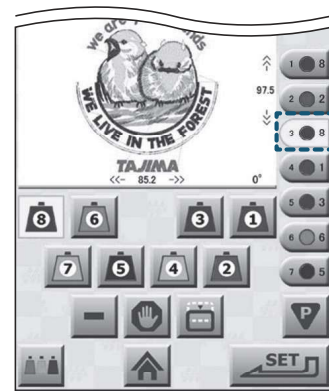

3. Repeat steps 1 and 2 until all steps have a needle number assigned to them.

4. Tap .

The step is set.

### 4.6.3 Bringing the frame out

While embroidery work is in progress, the machine can be paused and the frame can be brought out in front of the machine.

This feature can be conveniently used at times when, for example, you need to place appliqué on the fabric.

1. In the Needle No. Setting screen, tap the specific step where you would like to perform the frame out function.

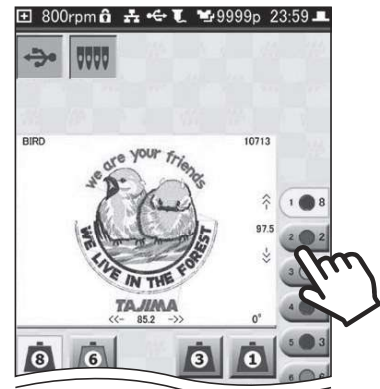

The icon of the step that was tapped and the needle No. set for the step are highlighted in yellow.

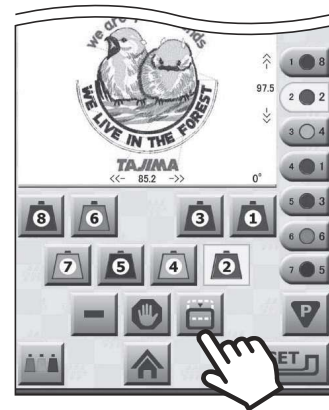

2. Tap .



The frame out function is added immediately after the step that was selected in step 1.

To erase the frame out function, tap  that was inserted to the step, and then tap .



3. Tap .

The step is set.

## 4.6.4 Pausing

While a step is in progress, the machine can be paused.

1. In the Needle No. Setting screen, tap one of the step icons to which the pause is to be added.

The icon of the step that was tapped and the needle No. set for the step are highlighted in yellow.

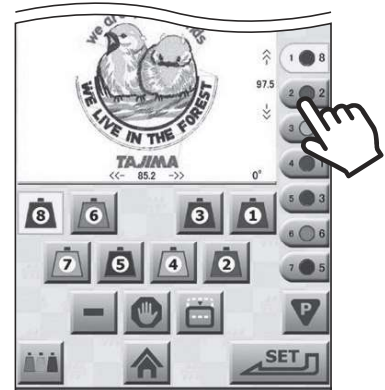

2. Tap .



A pause operation is added immediately after the step that was selected in step 1.

 To erase the pause operation, tap  that was added at the step, and then tap .

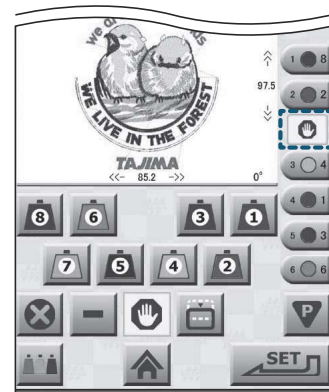

3. Tap .
- The step is set.

### 4.6.5 Repeating step

This function allows specific steps to be repeated. After the step repetition operation has been inserted, the step before that will be executed repeatedly.

1. On the Needle No. Setting screen, tap the icon for the step into which the step repetition is to be inserted.

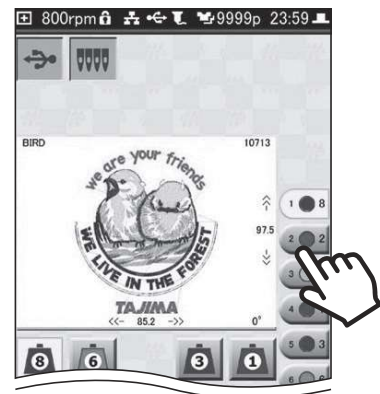

The icon of the step that was tapped and the needle No. set for the step are highlighted in yellow.

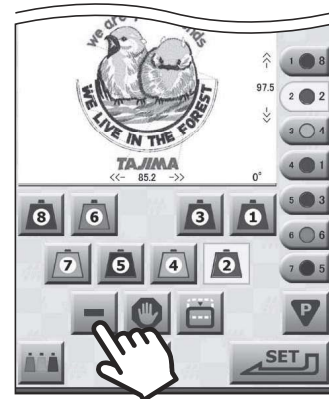

2. Tap .



The step repetition operation is added immediately after the step that was selected in step 1. Also, the steps that follow are no longer displayed.

 To erase the step repetition operation, tap  that was added at the step, and then tap .

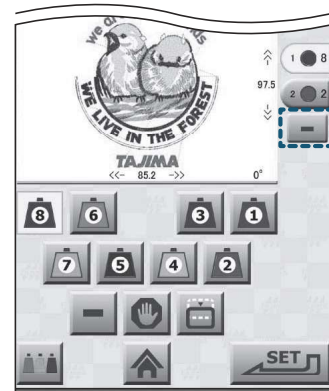

3. Tap .

The step is set.



## 4.7 Setting the thread colors

The thread color can be set for each needle No.

There are two ways of selecting thread colors. They can be selected from the database contained in the machine, or they can be selected from the color palette.

Setting method	Description
Select from the database	Selections from the database can be made for the thread's maker, name, code, and color.
Select from the color palette	The thread's color can only be selected from the color palette.



The thread colors set here will be reflected in the design and needle numbers shown on the screen.

### 4.7.1 Selecting from the database

1. Tap  on the Home screen.

The List of Thread Color Setting screen is displayed.

2. Tap .

The Thread Maker Setting screen is displayed.



3. Select the name of the thread maker, and then tap



The Thread Color Setting screen is displayed.



**4. Select the thread color, and then tap .**

Once the color has been selected, the [Name] and [Code] are displayed.

You are returned to the List of Thread Color Setting screen.

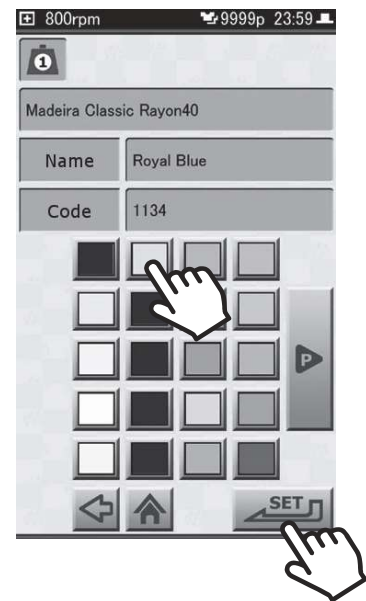



**5. Repeat steps 2 through 4 until the maker and color have been set for all needles up to needle No. 8.**

**6. Tap .**

You are returned to the List of Thread Color Setting screen.

## 4.7.2 Selecting from the color palette

1. Tap  on the Home screen.  
The List of Thread Color Setting screen is displayed.
2. Tap .  
The needle No. 1 Color Palette screen is displayed.



3. Select the thread color for needle No. 1, and then tap .  
The needle No. 2 Color Palette screen is displayed.

 Tap  in the lower-left part of the screen, and you are returned to the List of Thread Color Setting screen.

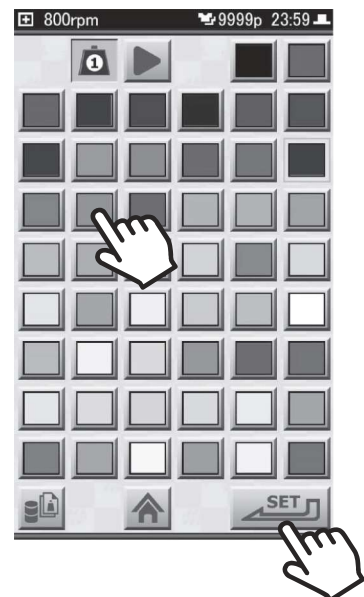

4. Repeat step 3 until the thread color has been set for all needles up to needle No. 8.
5. Tap .  
You are returned to the List of Thread Color Setting screen.

## 4.8 Bringing the frame out quickly

When the machine is stopped, the frame can be brought out quickly. This function can be conveniently used when you want to check the condition of the embroidery while it is being sewn, or when you want to change the frame.

### Caution

⊘ If the frame is brought out while thread is still attached to the fabric, the thread could go slack. And, in such cases, when the embroidery is restarted, the slack in the thread could stick out from the fabric. Please trim the thread manually beforehand to prevent this.

👉 "4.10.3 Trimming the thread manually"

⊘ Keep hands away from the area surrounding the frame. Otherwise, there is a risk of injury due to the movement of the frame.

### 1. Tap on the Home screen.

The frame moves toward you.

While the frame is moved out,  is displayed in light red.

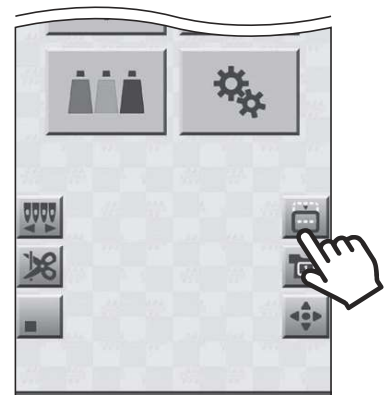

### 2. To return the frame, tap .

The frame goes back to its original position, and the Home screen is displayed.

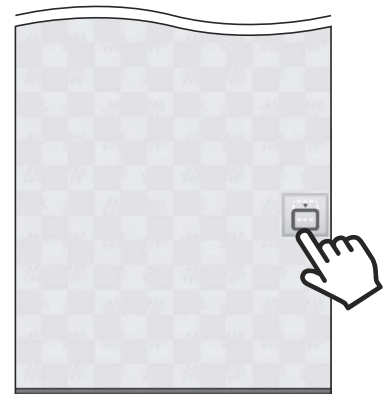

## 4.9 Returning frame/advancing frame according to design







The frame can be returned or advanced according to the design data. This feature comes in handy in the following situations.

- When you want to do some repair stitching after the thread has broken, and you want to restart the embroidery from the position before the thread broke.
- When you want to start embroidering from a place or step partway through the design.
- When you want to skip embroidery of a place or step partway through the design.

### Caution



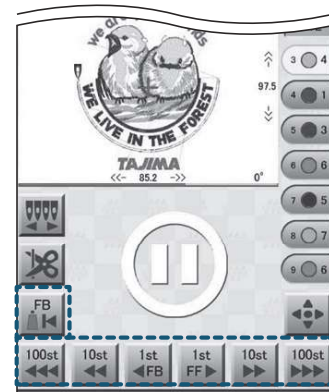

 Keep hands away from the area surrounding the frame. Otherwise, there is a risk of injury due to the movement of the frame.

### 1. Move the frame by tapping the icons below while in the Paused screen or the Embroidery Start screen.

- To go back 1 step: 
- To go back 100 stitches at a time: 
- To go back 10 stitches at a time: 
- To go back 1 stitch at a time: 
- To go forward 1 stitch at a time: 
- To go forward 10 stitches at a time: 
- To go forward 100 stitches at a time: 



 The frame can be returned one stitch at a time by pressing the [STOP] button on the operation panel while embroidery is paused. If you press and hold the [STOP] button, the frame will consecutively return, one stitch at a time.

 If , , or  is tapped on the Embroidery Start screen, a screen asking you to confirm that you want to move the frame is displayed. Tap [YES].

### ■ Example of use for repair sewing after thread breaks

After the thread breaks, if you restart from a position where the stitches overlap slightly, the resulting product will look better.

### 1. Tap , and return the frame to a position where two or three stitches can overlap a place where the sewing was all right.

With each tap of , the frame returns by one stitch.

### 2. Press the [START] button on the operation panel.

The embroidery resumes from the position at which the frame was returned.

## 4.10 Manual operation

When the machine is stopped, movement of the frame, needle bar changes, and thread trimming can be performed manually.

### 4.10.1 Moving the frame manually

The frame can be moved to any position you want.

When the frame can be moved manually,  is displayed on the screen.

#### Caution

 If the frame is brought out while thread is still attached to the fabric, the thread could go slack. And, in such cases, when the embroidery is restarted, the slack in the thread could stick out from the fabric. Please trim the thread manually beforehand to prevent this.

 "4.10.3 Trimming the thread manually"

 Keep hands away from the area surrounding the frame. Otherwise, there is a risk of injury due to the movement of the frame.

1. Tap . (Example: In the case of the Home screen)  
The frame travel keys are displayed.

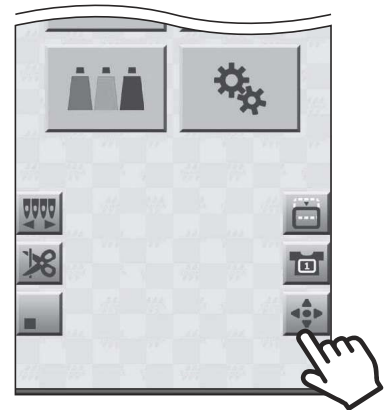

2. Press and hold the relevant arrow icon of the frame travel keys to move the frame to the position you want.  
The frame stops when you release your finger from the arrow icon.

 For details on the frame travel keys: "3.2.4 Moving the frame to the embroidery start point"

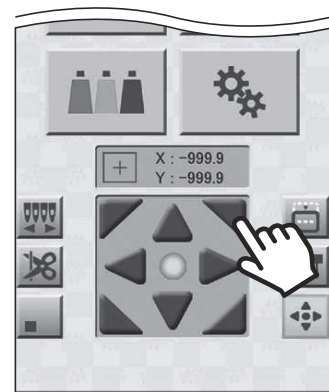

3. Tap  to return to the Home screen.

## 4.10.2 Manually changing the needle position

The needle for the sewing start point can be changed by sliding the needle bar case. When the needle bar case can be operated manually,  is displayed on the screen.

### Caution

- ⊘ If the frame is brought out while thread is still attached to the fabric, the thread could go slack. And, in such cases, when the embroidery is restarted, the slack in the thread could stick out from the fabric. Please trim the thread manually beforehand to prevent this.

👉 "4.10.3 Trimming the thread manually"

- ⊘ Keep hands away from the area surrounding the needle bar case. Otherwise, there is a risk of injury due to the movement of the needle bar case.

1. Tap . (Example: In the case of the Home screen)

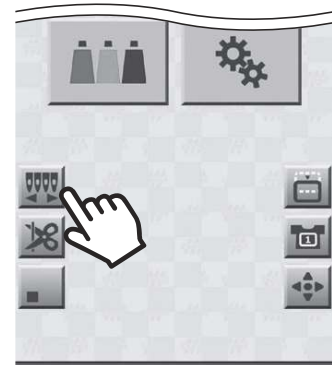

The Manual Color Change screen is displayed. In the color change screen, the needle No. at the current sewing start position is displayed.

  is displayed when the laser crosshair marker is lit.

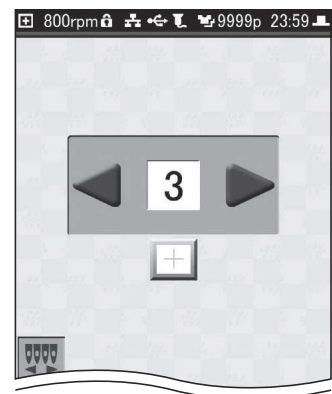

2. Tap  or .

With each tap of  , the needle bar case slides. Also, the indication for the needle No. changes.

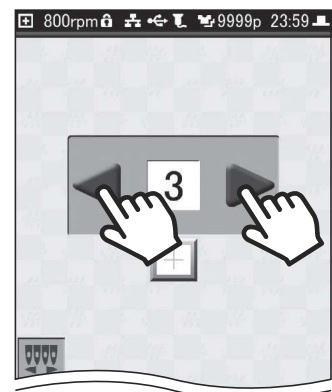

### 4.10.3 Trimming the thread manually

The thread can be trimmed manually.

When the thread can be trimmed manually,  is displayed on the screen.

#### Caution

 Keep hands away from the area surrounding the needles and frame. Otherwise, there is a risk of injury when the needles come down and the frame moves.

1. Tap . (Example: In the case of the Manual Color Change screen)

Thread is trimmed.

Also, while the thread is being trimmed, an hourglass is displayed on the screen.

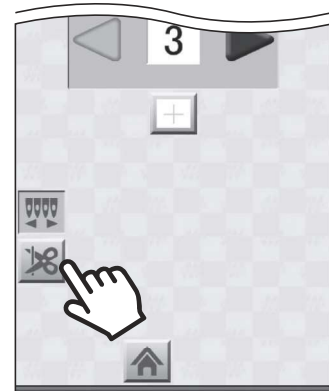

4





## 4.11 Using the laser crosshair marker

The laser crosshair marker provides a cross-shaped laser illuminated area on the fabric, which indicates the position the needle will fall.

When lighted, the laser crosshair marker makes it easy to adjust positioning when the frame is moved, such as when moving the frame to a position to be embroidered.

 The laser crosshair marker can be lighted from the Home screen, the Ready to Embroider screen and in the Embroidery Paused screen.

 "1.2 Home screen", "3.2.7 Starting the embroidery", "3.2.8 Pausing the machine"

 If the frame is brought out while thread is still attached to the fabric, the thread could go slack. And, in such cases, when the embroidery is restarted, the slack in the thread could stick out from the fabric. Please trim the thread manually beforehand to prevent this.

 "4.10.3 Trimming the thread manually"

### Caution

 Keep hands away from the area surrounding the needle bar case. Otherwise, there is a risk of injury due to the movement of the needle bar case.

1. Tap . (Example: In the case of the Manual Frame Position Setting screen)

The Color Change screen is displayed.

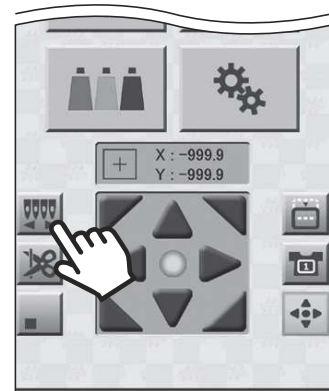

2. Tap .

The needle bar case moves to the position of the laser crosshair marker. The laser crosshair marker lights up, and the place where the needle will fall is shown in the crosshairs.

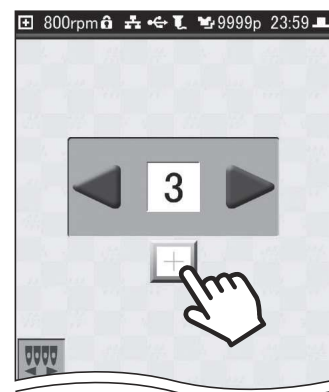

3. To turn off the laser crosshair marker, move the needle bar case using   in the Color Change screen.

## 4.12 Using design creation software



Designs can be created on a PC using the dedicated design creation software or a separately available DG product.

Once a design is created, USB memory (USB flash drive) or the network functionality can be used to load the design into the machine, and use it for embroidery.

Please contact your sales dealer for information on how to obtain the design creation software, how to install it, and how to use it.

# Chapter 5 Lettering Embroidery

Text such as initials or names can be embroidered using combinations of the fonts stored in the machine.

-  Designs created using the lettering embroidery function can consist of only one color.
-  Textual embroidery designs that have been created are automatically given a file name when they are stored in Record.

## 5.1 Lettering embroidery

After selecting a font, characters are entered to create the lettering design. Lettering design, which have been embroidered at least once, are stored in the Record.

### 1. Select on the Home screen.



The Font Selection screen is displayed.

### 2. Select the font to be used, and then tap .

The Maximum Width of Text Setting screen is displayed.

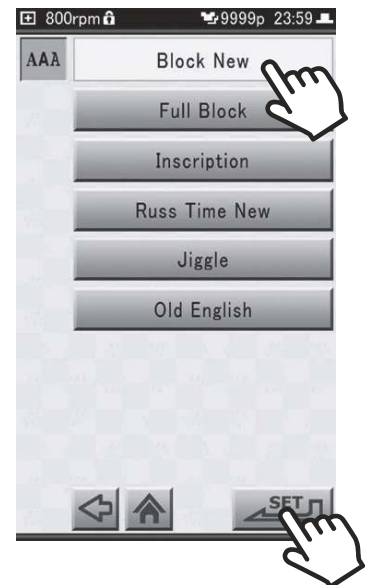
-  The fonts [ひらがな], and [カタカナ] are displayed only when the language of the operation panel is set to 日本語 (Japanese).





3. Use   to set the maximum width of the character string, and then tap .

The Text Height Setting screen is displayed.

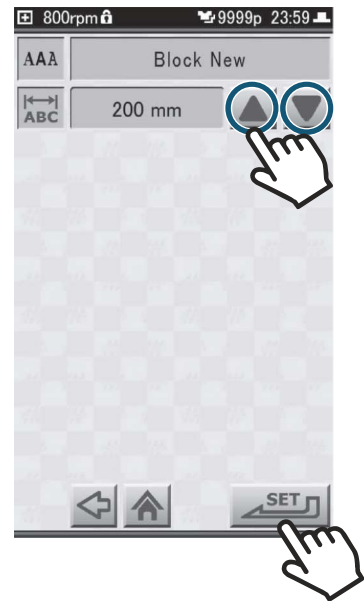
 The maximum width of the character string can be set to any value from 5 to 300 mm.





4. Select the character height, and then tap .

- To set character height to 7 mm: 
- To set character height to 15 mm: 
- To set character height to 30 mm: 

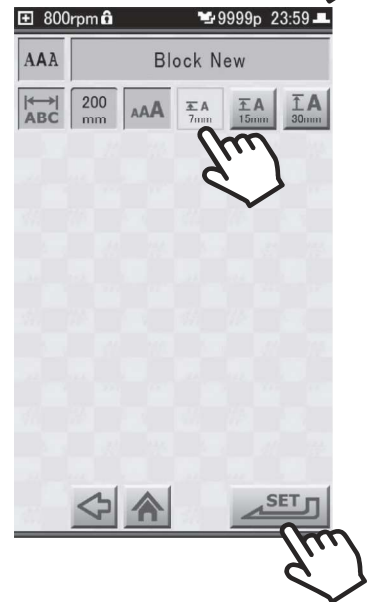
The Text Entry screen is displayed.



5. Enter the text to be embroidered, and then tap .

 If you want to enter numerals, special symbols, etc., tap the   to switch pages.

 To erase a character that has been entered, tap .



The Confirm Image screen is displayed.

- 1: Name of design
- 2: Image of design
- 3: Horizontal width of set design (in mm units)
- 4: Number of stitches in design
- 5: Height of set design (in mm units)

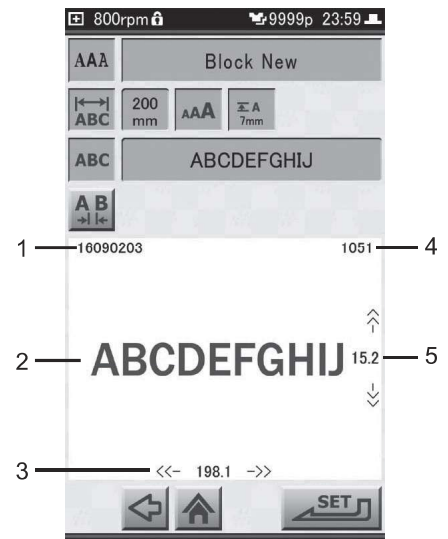

## 6. Tap .

The character spacing selection icons ([Whole] or [Part]) are displayed to the right of the icon.

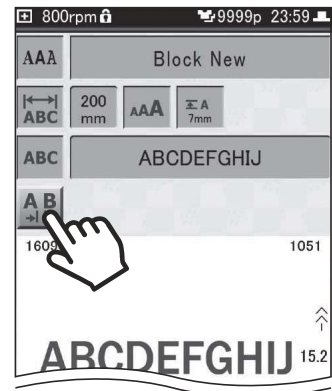



## 7. Select the character spacing, and then tap .

- To make spacing between the characters uniform: [Whole]
- To individually set space between characters: [Part]

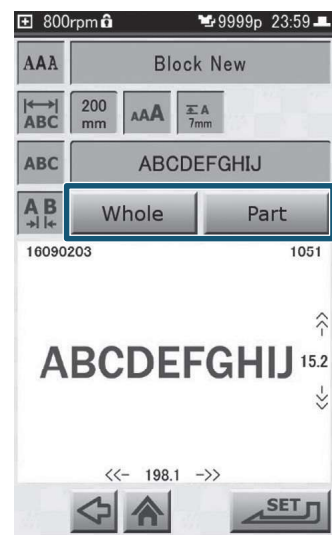
The character spacing setting icons are displayed.



8. If [Part] was tapped in step 7, tap   and select the two characters for which the spacing is to be set.

 The character spacing can be set to any value from -50 to 100 mm. (The default setting is 0.5 mm.)

 The two characters that were selected are displayed in red.

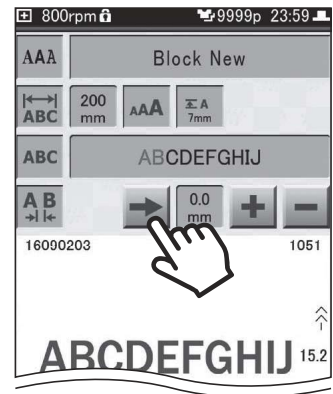

9. Using  , set the character spacing.

If [Part] was selected in step 7, repeat steps 8 and 9 to set the character spacing for any character positions that need adjustment.

 If the maximum width of a character string is exceeded while setting the character spacing, an error screen is displayed. In such a case, tap [RESET] and change the character spacing.

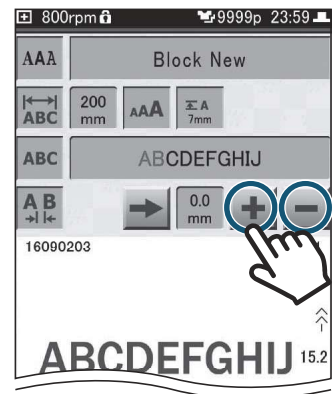

10. After setting the character spacing, tap .

You are returned to the Confirm Image screen, and the character string is displayed using the character spacing that was set.

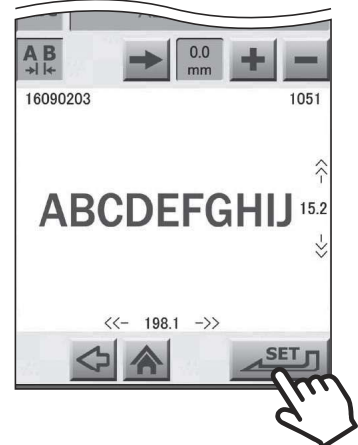

11. To complete the settings for the character string, tap  in the Confirm Image screen.

The Needle No. Setting screen is displayed. Set the thread color and needle No.

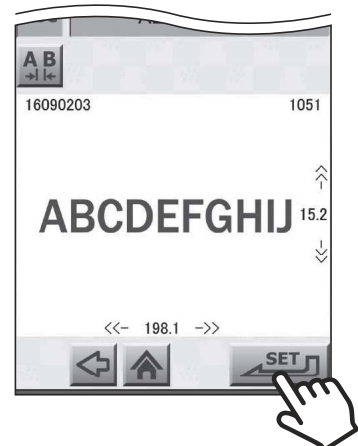

# Chapter 6 Setting the Machine

Settings for the machine, such as those for the embroidery frame or those on how the machine is to be used, are explained in the following.

Please refer to this chapter for the convenient settings, such as if you would like to adjust the settings of the network and frame movement, or change the wallpaper of the operation panel.

## 6.1 Adjusting the embroidery settings

The chart below shows how the embroidery parameters are originally set. These settings can be changed as necessary.

Function	Details	Setting	Default setting
Thread Detection	Detects any breakage in the upper/under thread.	YES/NO	YES
Return stitches	Determines whether to sew return stitches at the start of embroidery.	YES/NO	YES
Length of upper thread to remain after trimming thread	Length of upper thread to remain after thread is trimmed	Long/Middle/Short	Middle
Return to marker position	Whether to move the needle bar case to the position of the laser crosshair marker when the embroidery is finished	YES/NO	YES
Jump code	Conditions governing thread trimming partway through a design	[1J] to [9J]	3J

### ■ Displaying the Embroidery Setting screen

**1. Tap  on the Home screen.**

The Setting screen is displayed.

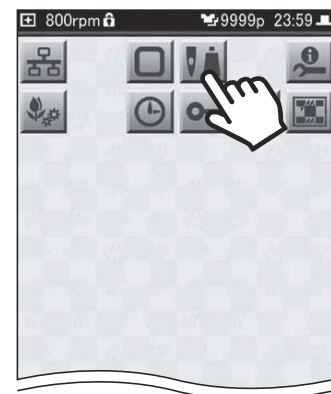

**2. Tap .**

The Embroidery Setting screen is displayed.

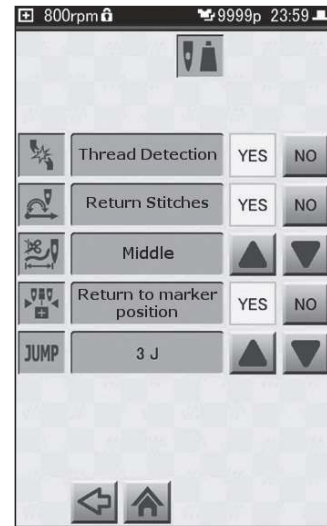



3. Once the setting has been made, tap . You are returned to the Setting screen.

 To cancel a setting, tap .

A confirmation screen is displayed, tap [YES], the selected setting will return to its previous state.

### 6.1.1 Detecting thread breakage

This setting specifies whether or not breakage of the upper thread or under thread is to be detected. When enabled, the machine will be stopped when thread breakage is detected. When disabled, the machine won't stop even if the thread breaks, and the embroidery will continue.

1. Display the Embroidery Setting screen.
2. Tap [YES] or [NO] for [Thread Detection].
  - To detect thread breakage: [YES]
  - To not detect thread breakage: [NO]

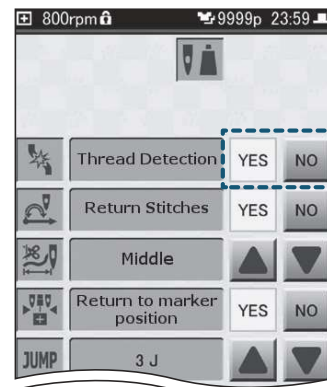





## 6.1.2 Sewing return stitches at the beginning of the embroidery

This setting determines whether or not return stitches are sewn at the beginning of the embroidery. When this setting is enabled, return stitches—two times back and fourth—are sewn at the beginning of embroidery.

When return stitches are sewn, problems at the beginning of the embroidery can be reduced. There will also be less chances for the thread to pull out.



-  Enable the setting for return stitches when the beginning stitches of a design is unstable.
-  Some designs are already set so return stitches are sewn.

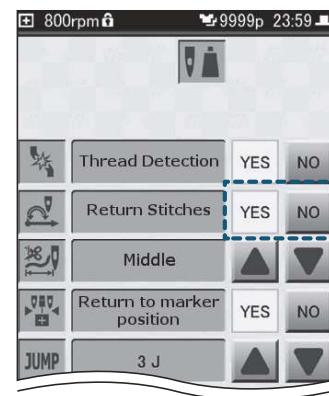

1. Display the Embroidery Setting screen.
2. Tap [YES] or [NO] for [Return Stitches].
  - To sew return stitches: [YES]
  - To not sew return stitches: [NO]



## 6.1.3 Changing length of upper thread after trimming

Select from the following to set the length of upper thread that remains after the thread is trimmed. Long, Middle (default setting), and Short are the 3 settings that can be selected from.

-  If the end of the upper thread is visible on the front of the embroidery in places where sewing started, set this to [Middle] or [Short].
-  If the thread does not link correctly where embroidery is started, and embroidery cannot be carried out properly, set this to [Long].
-  When metallic type threads such as gold or silver are used, setting this to [Long] can help stabilize the start of embroidery.

1. Display the Embroidery Setting screen.
2. Using   of , change the setting.

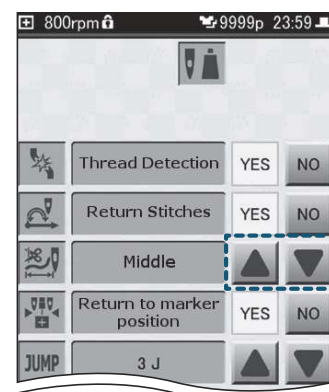

## 6.1.4 Moving the needle bar case after the design has been embroidered

This setting determines whether or not the needle bar case moves to the position of the laser crosshair marker after the design has been embroidered, and the laser crosshair marker lights. Having the laser crosshair marker light makes it easier to decide the position of the next design to be embroidered.

### Caution

**⚠ Before the laser crosshair marker lights, the needle bar case moves to the center position. Keep hands away from the needle bar case while it is moving. Otherwise, there is a risk of injury.**

1. Display the Embroidery Setting screen.
2. Tap [YES] or [NO] for [Return to marker position].
  - To move the needle bar case: [YES]
  - To not move the needle bar case: [NO]

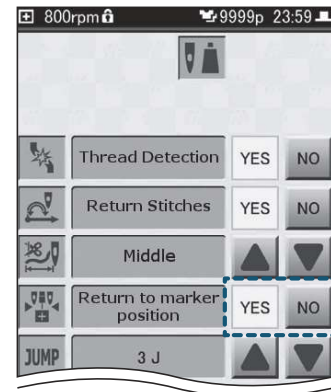

## 6.1.5 Settings for automatic thread trimming

In some cases, the thread needs to be trimmed partway through a design. For example, between letters when the same needle No. is to be used for the letters. Whether or not the thread is to be trimmed can be set using the number of jump stitches (stitches where needle does not come down). At the default setting of [3J], the thread is automatically trimmed in places where jump stitches continue for 3 or more stitches.

1. Display the Embroidery Setting screen.
2. Using ▲ ▼ of JUMP, change the displayed setting.
  - Trim the thread after these number of jump stitches: [1J] to [9J] (1 to 9 stitches)
  - Thread is not to be trimmed: [NO]

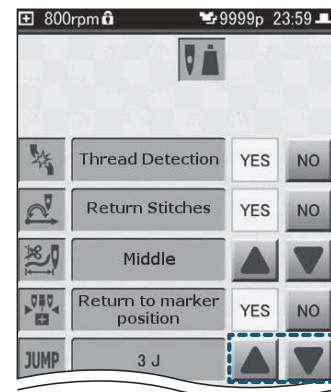

## 6.2 Frame settings

### 6.2.1 Setting the type of frame to be used

The frame settings need to be modified according to the type of frame to be used.

#### Caution

- ⚠ If the settings are not suitable for the frame being used, the frame could come into contact with parts of the machine and cause damage to the frame or the machine itself. Make sure the setting matches the type of frame to be used.

#### 1. Tap on the Home screen.

The Frame Type Selection screen is displayed.

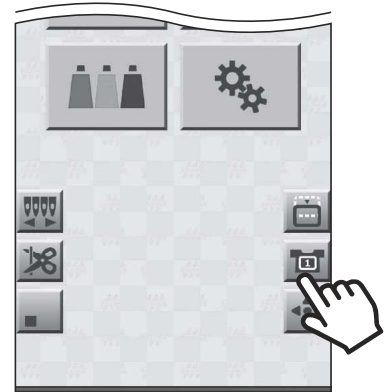

#### 2. Select the type of frame to be used.

- When using the large-sized frame (200 × 300): [Tubular 1]
- When using the small-sized frame (100 × 100): [Tubular 2]
- When using the cap frame (optional): [Cap]

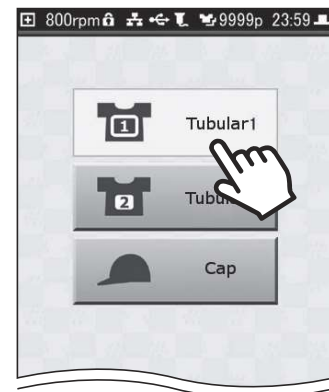

## 6.2.2 Memorizing the frame origin

Whenever you change to a different type of frame, the frame origin needs to be memorized in the machine.

The "frame origin" refers to the absolute coordinate values (X: 0.0, Y: 0.0) that are used for reference when calculating the current position of the frame.

If the frame origin is incorrect, not only will the following problems occur, the needle or presser foot may also come into contact with the frame during embroidery, causing damage as a result.

- The frame coordinates are not displayed correctly.
- Discrepancies occur with regard to the permissible range of movement for the frame.

➔ "6.2.4 Setting the permissible range of movement for the frame"

### Caution

⚠ Do not place hands or anything else near the frame when any of the following are being carried out. Otherwise, there is a risk of injury due to the movement of the frame.

1. Tap  on the Home screen.

The Setting screen is displayed.

2. Tap .

The Frame Setting screen is displayed.

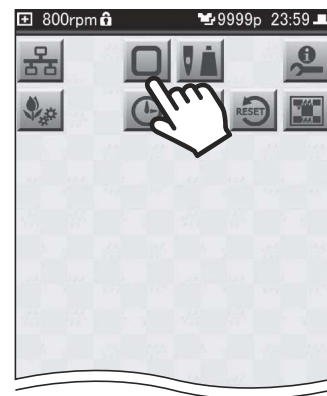

3. Tap .

A confirmation message is displayed.

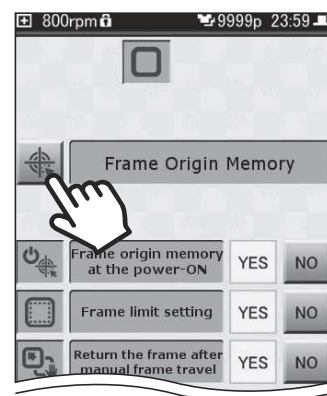

**4. Tap [YES].**

The frame moves, and the process for memorizing the frame origin is carried out.

Once the frame origin has been successfully memorized, you will be returned to the Frame Setting screen.



### 6.2.3 Memorizing the frame origin upon power up

This setting determines whether or not a message related to memorizing the frame origin is displayed when the machine's power is turned on.

**1. Tap  on the Home screen.**

The Setting screen is displayed.

**2. Tap .**

The Frame Setting screen is displayed.

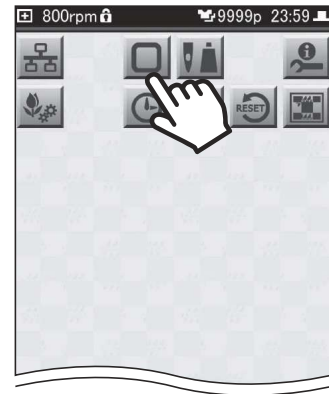

**3. Tap [YES] or [NO] for [Frame origin memory at the power-ON].**

- To display a message concerning memorization of the frame origin when the machine is powered up: [YES] (default setting)
- To not display a message concerning memorization of the frame origin when the machine is powered up: [NO]

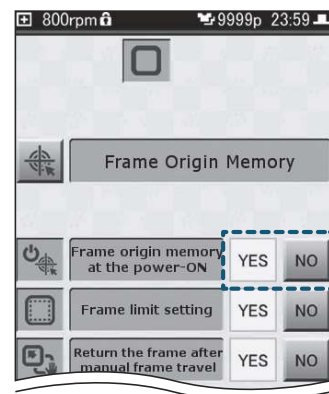

**4. If [NO] was selected in step 3, a confirmation message is displayed, so tap [YES].**

Once the setting has been completed, you will be returned to the Frame Setting screen.

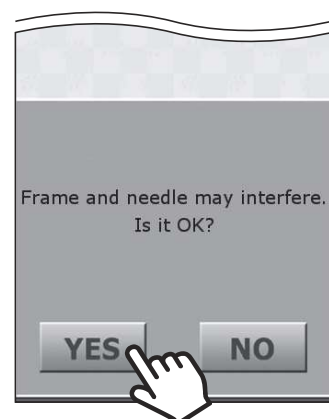

## 6.2.4 Setting the permissible range of movement for the frame

This setting determines whether or not a permissible range of movement (frame limits) for the frame is to be set.

The machine is originally set so that the frame cannot be moved beyond the range inside the frame in which embroidery can be performed. This is in order to prevent needles or the presser foot from hitting the frame while embroidery is in progress.

When this setting is disabled ([NO]), the embroidery range can be extended to the maximum, up to the point immediately before the needle or presser foot might hit the frame.

### Caution

⚠ With this setting disabled, the needle or presser foot may come into contact with the frame during embroidery, resulting in possible damages. Whenever possible, embroidery should be carried out with frame limits enabled ([YES]).

✍ In order to make this setting, the frame origin needs to be correctly stored in memory.  
 👉 "6.2.2 Memorizing the frame origin"

1. Tap  on the Home screen.  
 The Setting screen is displayed.

2. Tap .  
 The Frame Setting screen is displayed.

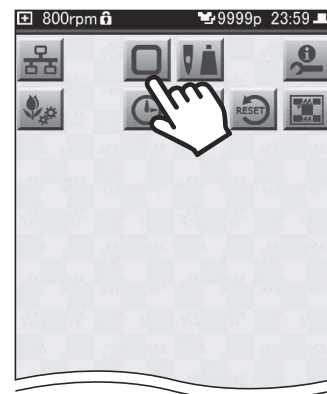

3. Tap [YES] or [NO] for [Frame limit setting].

- To move the frame only within the area defined by the frame limits, and stop the embroidery whenever the frame limits are exceeded: [YES] (default setting)
- To have the frame not stop at the frame limits: [NO]

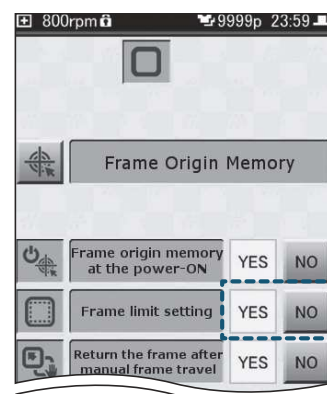

**4. If [NO] was selected in step 3, a confirmation message is displayed, so tap [YES].**

Once a setting has been completed, you will be returned to the Frame Setting screen.

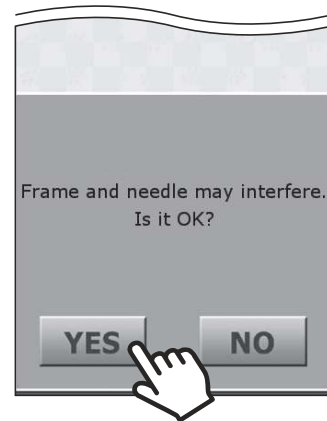

## 6.2.5 Returning the frame to its original position after manually moving it

This setting determines whether or not the frame is to be moved back to the original point after it has been moved manually when the machine was stopped partway through a design.

### Caution

**Do not place hands or anything else near the frame when any of the following are being carried out. Otherwise, there is a risk of injury due to the movement of the frame.**

**In order to make this setting, the frame origin needs to be correctly stored in memory.**  
 ➔ "6.2.2 Memorizing the frame origin"

**1. Tap  on the Home screen.**

The Setting screen is displayed.

**2. Tap .**

The Frame Setting screen is displayed.

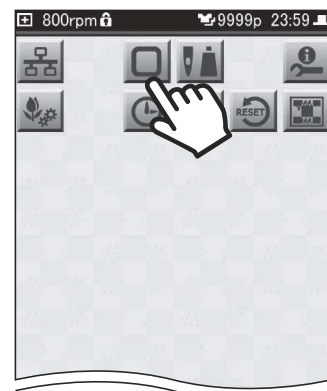



### 3. Tap [YES] or [NO] for [Return the frame after manual frame travel].

- To have the frame move back to its original position after it has been moved manually, and then resume the embroidery: [YES] (default setting)
- To resume the embroidery from the current position of the frame, where it was moved to manually: [NO]

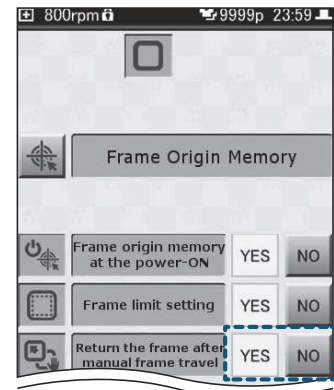

## 6.3 Performing network settings

Here's how to make the settings necessary for using a network. Once these settings have been made, you can connect a LAN cable and load designs from a PC.

### Caution

**To connect to a network, you will need to have a commercially available LAN cable and router or other network devices.**

➔ "4.4 Loading a design from a PC using a LAN cable"

### 1. Tap on the Home screen.

The Setting screen is displayed.

### 2. Tap .

The Network Setting screen is displayed.

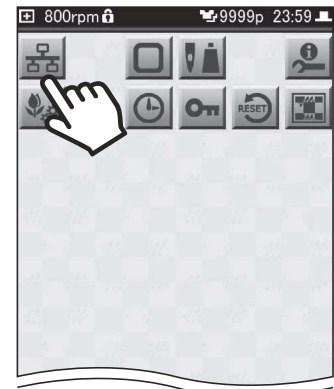

### 3. Tap [Network], then select how the network is to be used.

- To not use the network: [NO]
- To consecutively load designs that have been sent by a PC: [Auto]
- To select designs sent by a PC in the Design List screen: [Manual]

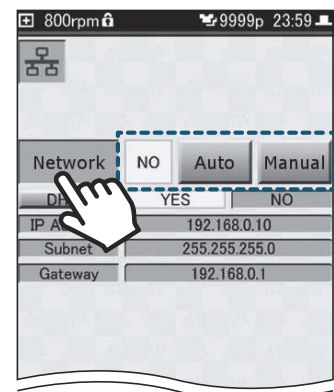

#### 4. Tap [DHCP], and then select [YES] or [NO].

- When using a DHCP server or router: [YES]
- When manually setting network addresses such as the IP address: [NO]

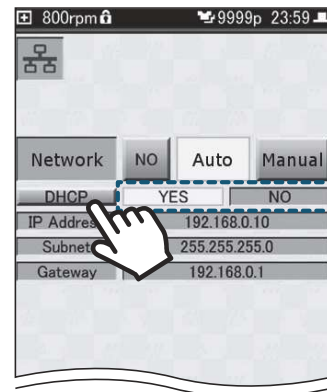





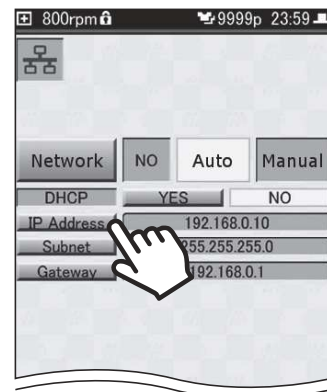

#### 5. If [NO] was selected in step 4, tap [IP Address], [Subnet], [Gateway].

The numeric keypad is displayed.



#### 6. Enter each address using the numeric keypad, and then tap .

The network address is set.

-  We recommend using the network address values that were set for the machine beforehand. If you want to change the network addresses, please consult with your sales dealer.
-  The default values for the addresses are as follows:
  - [IP Address]: 192.168.0.10
  - [Subnet]: 255.255.255.0
  - [Gateway]: 192.168.0.1
-  Only IPV4 addresses are supported.
-  Tap  , and the cursor moves to the upper or lower three digits.

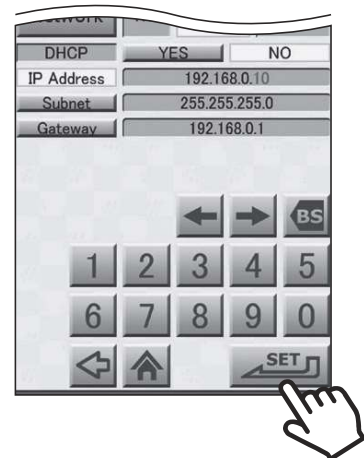

## 6.4 Setting the date and time

1. Tap  on the Home screen.

The Setting screen is displayed.

2. Tap .

The Date/Time Setting screen is displayed.

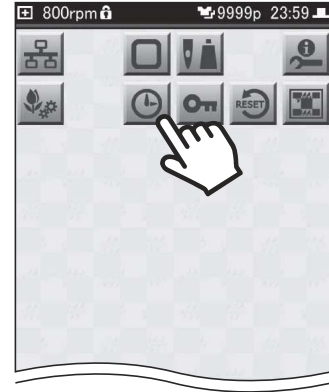

3. Set the date and time using  , and then tap



You are returned to the Setting screen.



## 6.5 Setting the language used for display on the operation panel

1. Tap  on the Home screen.

The Setting screen is displayed.

2. Tap .

The Info/Maintenance Setting screen is displayed.

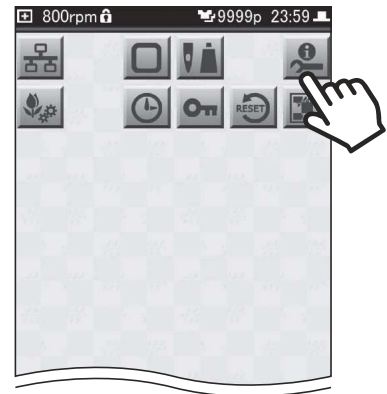

3. Tap .

The Language Setting screen is displayed.

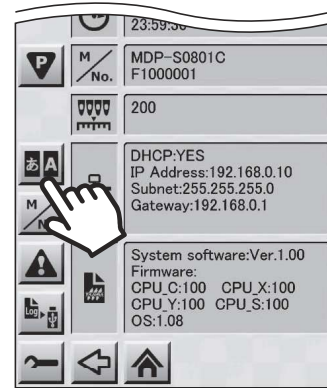

4. Tap [ 日本語 (Japanese) ] or [ English ].

 Tap  to return to the previous screen, and the display language will change.

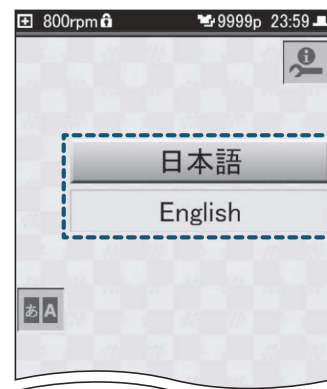

## 6.6 Displaying information about the machine



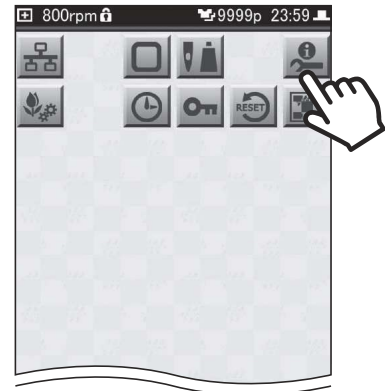

The current date and time, model name, and other information about the machine can be checked as follows:

1. Tap  on the Home screen.  
The Setting screen is displayed.

2. Tap .



The following is displayed on the Info/Maintenance Setting screen.

-  The date and time currently set on the machine
-  Upper row: model name; Lower row: machine number
-  Color change potentiometer value (numerical value of sensor that indicates needle position)
-  Network settings of the machine
-  Machine's software version information

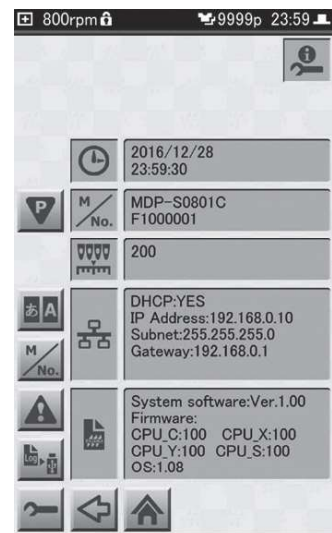

## 6.7 Changing the wallpaper color on the operation panel

The wallpaper color on the operation panel can be changed as follows.  
The current wallpaper is displayed in the Wallpaper Setting screen.

1. Tap  on the Home screen.  
The Setting screen is displayed.

2. Tap .  
The Wallpaper Setting screen is displayed, and the current wallpaper is displayed.

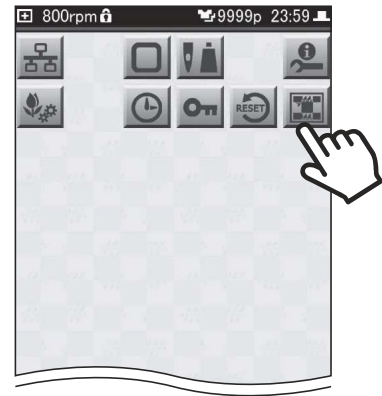

3. Select the color of wallpaper using  , and then tap .

-  The wallpaper color can be selected from the following:
- Green
  - Gray
  - Pink
  - Yellow
  - Blue

You will be returned to the Setting screen.

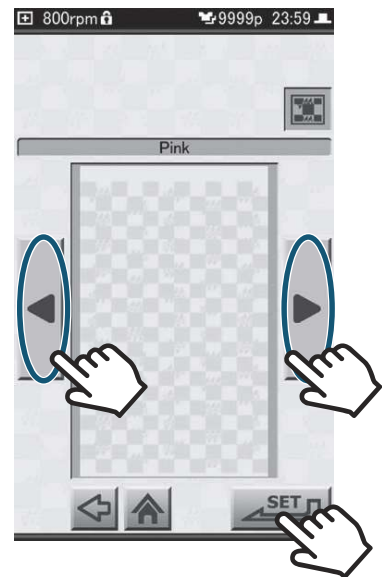















## 6.8 Other settings

The functions and settings below, which are not explained in this manual, were pre-set so as to assure the proper operation of the machine, and are used by service personnel when performing maintenance tasks.

Do not change these settings.

### Caution

 The machine may fail to operate normally if any of these settings are changed.

Icon	Description
	Machine Number Setting
	Error Stack Display
	Memory Backup
	Maintenance—Return to the fixed position of main shaft
	Maintenance—Motor Excitation
	Maintenance—Touch panel compensation
	A.S. after Auto Data Set
	Input of Test Design
	Password Setting
	Startup Lock
	Time-based Functional limit
	Design Related Setting
	Usage of Condition Data Associated with Design
	Parameter Settings Reset
	Design Record and Error Stack Erasure
	Factory Defaults Reset

# Chapter 7 Using Optional Accessories

This chapter explains how to use optional accessories.

## 7.1 Using the cap frame

By using a separately sold cap frame, you can embroider visored caps.

### Caution

⊘ Please take note of the following things regarding use of a cap frame.

#### ■ Type and size

When using a cap frame, you can embroider visored caps.

Do not use the following types of items, since the embroidered results will not be good, and it could lead to bent needles and the malfunction of the machine.

- Hats that are not of the cap type
- Hats made of fabric that tends to get wrinkled or stretches and contracts easily
- Hats that are of a size that won't fit in the cap frame (small hats or extremely shallow hats)

#### ■ Range within which embroidery can be carried out

When sewing designs using the cap frame, allow at least 10 mm distance from the stitching of the visor, and use only designs that will fit within the embroidery area shown below.

- Vertically: 75 mm or less
- Horizontally: 300 mm or less

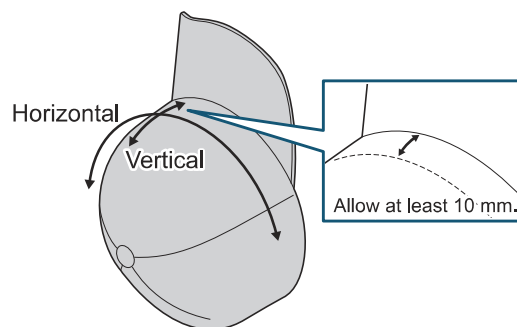

### 7.1.1 Attaching the cap frame unit to the machine

#### Caution

⊘ Switch power off before starting the following procedure.

1. Attach the base of the ring shaft at the place for installing the ring shaft at the lower part of the bed, and fasten it with the screw.

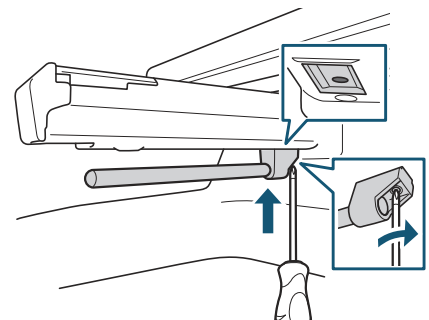



- 2.** Loosely screw in the knobbed screws (two places, at right and left) at the lower part of the frame drive system.

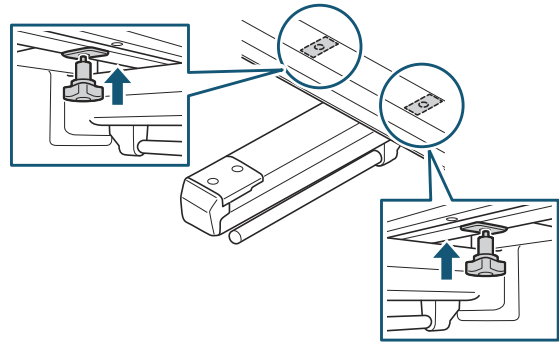

- 3.** Position the center, cylindrical part of the cap frame unit onto the ring shaft, and slide the cap frame unit in, along the ring shaft.

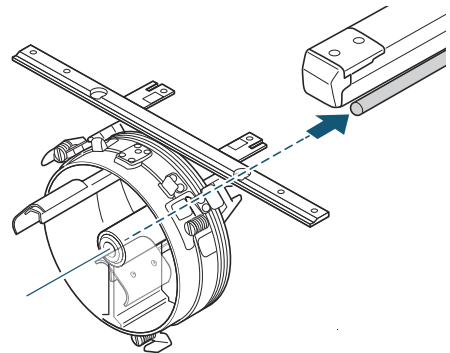

- 4.** On the connecting part of the cap frame unit there are two slits (at right and left). Slide in the cap frame unit until these two slits are engaged by the two knobbed screws, and until the unit cannot be pushed in any further.

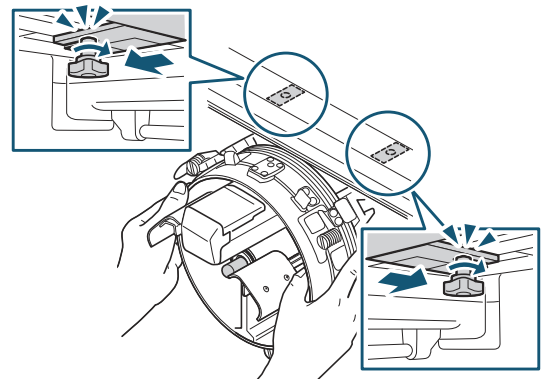

 If the interconnecting portion of the cap frame unit is difficult to push in when attaching the cap frame unit for the first time, try loosening the fastening screw of the revolving ring and adjusting the position.

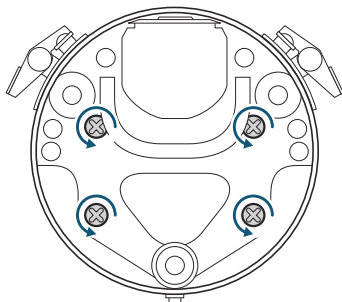

- 5.** Tighten the knobbed screws (two places, at right and left) that were attached in step 2.

- Turn the drive ring to move the connecting sashes right and left, so the screw holes in the connecting sashes are lined up with the positions of the screw holes in the moving part (two places, at right and left).



If the screw holes are not aligned, slightly loosen the knobbed screws at the lower part (two places, at right and left) set in step 2, and tighten them after aligning the screw holes.

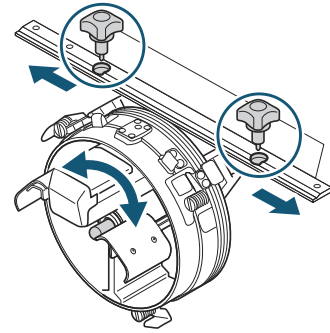

- Insert the knobbed screws into the screw holes in the movable part and fasten them.

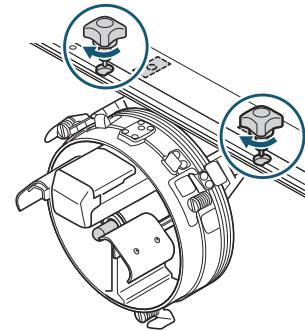

### 7.1.2 Positioning a cap on the cap frame

- Install the mounting jig on a stable surface such as a table or stand, and use the clamp to fix it in place.
- Place the cap frame over the tubular part of the cap frame gauge.

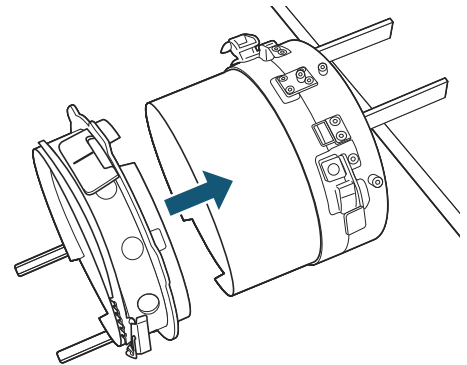

- Align the cutout portion of the cap frame with the position of the guide on the gauge and push in the cap frame.

Keep pushing in until the lock levers (two places) click into place, and the cap frame is secured.

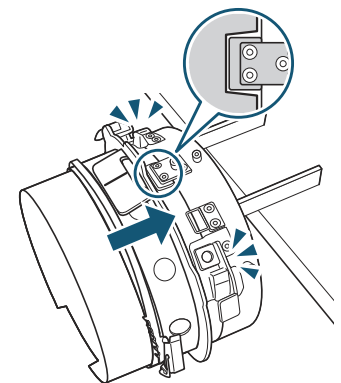

- 4. Remove the fastening band from the cap frame, and place the backing on the surface of the holder of the cap frame.**

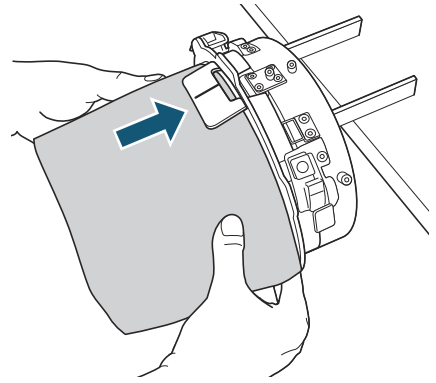

- 5. Pull out the sweatband from the cap so it is on the outside.**

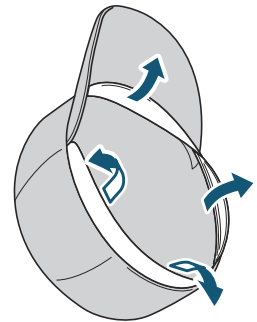

- 6. Position the visor of the cap so it faces directly upwards, and insert the sweatband under the holder on the cap frame.**

Push the cap in until the visor reaches the forward edge of the holder.

Also, adjust the positioning of the cap so that the center of its visor is aligned with the guide line.

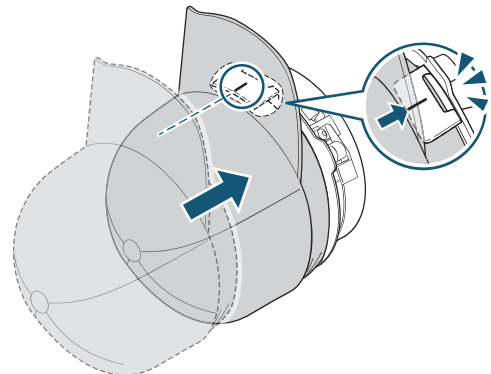

- 7. Position the fastening band along the base of the cap's visor, then fasten it with the latches.**

 If the fastening band is loose, or too tight, and the cap cannot be held in place using the latch, adjust the position of the latch holder.

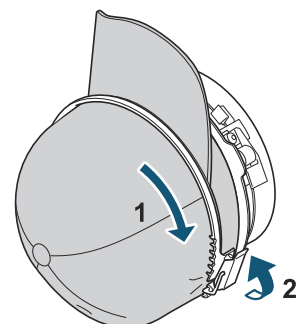
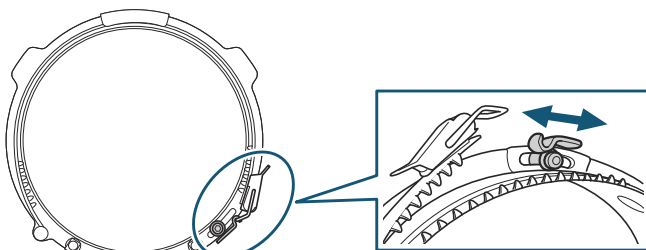

8. Pull the fabric downward so that the portion to be embroidered is stretched out properly.
9. Smooth out the fabric of the cap, then secure it by attaching clips to the clip holders (two places).

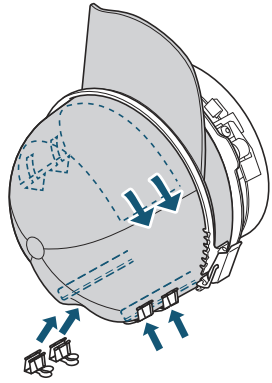

10. Press the lock levers (two places) on the gauge, and then pull off the cap frame from the gauge.

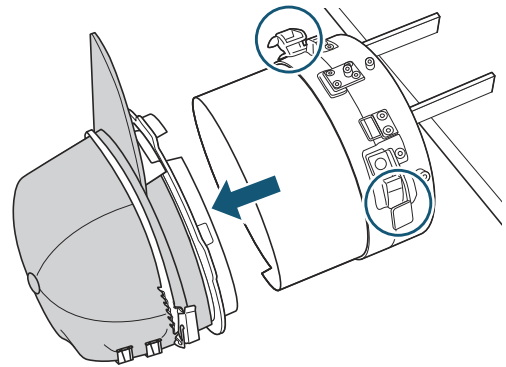

### 7.1.3 Positioning the cap frame on the cap frame unit

1. While turning the visor of the cap to the right so it will not make contact with the machine, insert the cap frame in the drive ring.
2. Adjust the direction of the cap frame so the visor of the cap faces directly upwards.

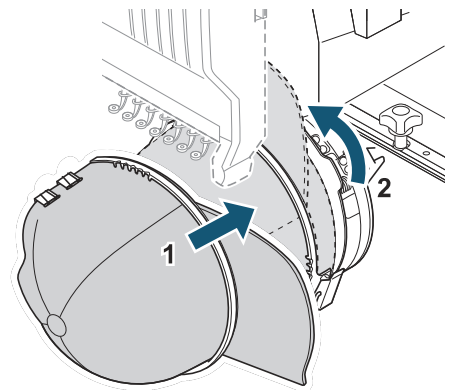

### 3. Align the cutout portion of the cap frame with the position of the guide on the drive ring and push in the cap frame.

Keep pushing in until the lock levers (three places) click into place, and the cap frame is secured.

 If the cap is shallow, change the position at which the needle plate guide of the cap frame unit (two places, at right and left) is attached so that the cap frame can be set in place correctly.

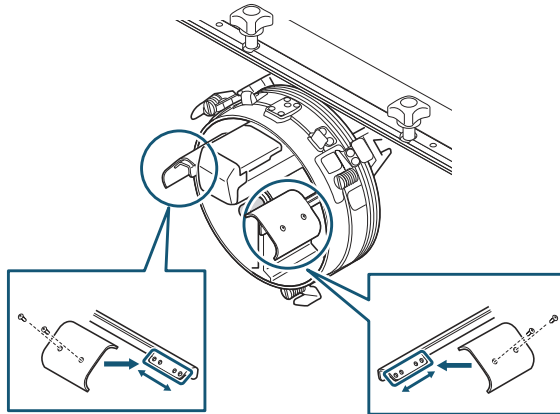

 If it is difficult to lock the cap frame, try doing it while lifting the lock lever.

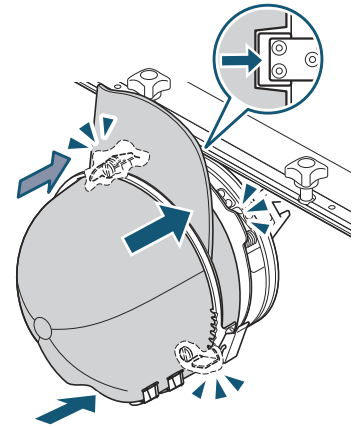

## 7.1.4 Changing the settings for the frame

### 1. Tap on the Home screen.

The Frame Selection screen is displayed.

### 2. Tap [Cap].

This completes the steps necessary to get ready to embroider using the cap frame.

 **How to start the embroidery:** "Chapter 3 How to Perform Embroidery"

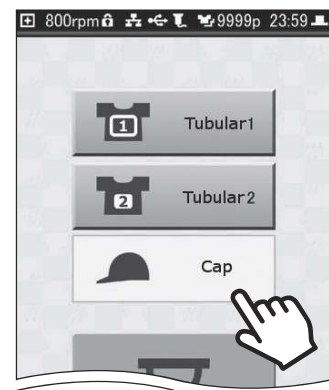

## 7.1.5 Removing the cap frame

Once the embroidery is complete, remove the cap.

1. Press the lock levers (three places), and remove the cap frame.
2. Remove the clips that were attached to the clip holders.

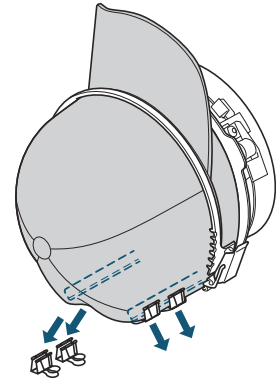

3. Open the latches, and remove the fastening band from the cap.

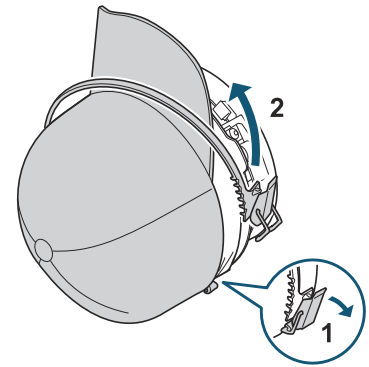

4. Remove the cap from the cap frame.

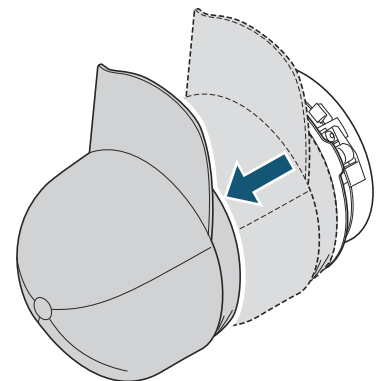

# Chapter 8 Appendix

In this chapter you will find information regarding needles and threads, which can help you create beautiful embroidery, instructions on how to perform routine maintenance for the machine, and measures to take when problems are encountered.

## 8.1 Producing beautiful embroidery

The following shows some representative examples of fabric, thread, and needle combinations to improve the quality of the finished embroidery. Please follow these recommendations.

Fabric	Upper thread		Needle size (*2)
	Material	Size (*1)	
Thin fabrics such as georgette and organdy	Polyester, rayon	75d/2 or 120d/2	No. 9 through 11
Felt, knitted fabrics such as T-shirts			No. 9 through 12
Caps, thick fabrics such as denim		120d/2	No. 11 through 14

(\*1) Indicated in denier format. The higher the number, the thicker the thread. The lower the number, the thinner the thread.

(\*2) The lower the number, the finer the needle. The higher the number, the thicker the needle.



**Fine needles such as No. 9 should be used for thin fabrics.**



**To prevent the breakage of the needle or the thread when embroidering thick fabrics, such as caps and denim products, use thick needles such as No. 12 or 14.**



**Switch to finer needles if the holes left after embroidery tend to stand out.**

## 8.2 Maintenance

Regular maintenance is important to assure reliable, long-lasting use of the machine. In addition to periodically cleaning the machine, you should also apply oil at the specified locations.

### 8.2.1 Cleaning the machine

The places shown below must be cleaned on a routine basis.

Place extra care on keeping the area around the rotary hook and thread trimming knife clean, since waste thread, dust, etc. tend to accumulate there. If not kept clean, the quality of the embroidery may deteriorate. Make sure to adhere to the cleaning schedule.

Places to clean	Frequency	Supplied accessories used
Machine itself, operation panel	Routine	—
Inside needle plate	Once a week	Z-shaped screwdriver Brush
Inside the rotary hook	Once a week	Brush
Inside the bobbin case	Once a week	Brush
Tension base	Once a week	Brush

#### Caution

⊘ Switch power off before beginning the cleaning.

#### ■ Inside needle plate

1. Use the Phillips end of the Z-shaped screwdriver to remove the screws from the needle plate, and then remove the needle plate from the bed.

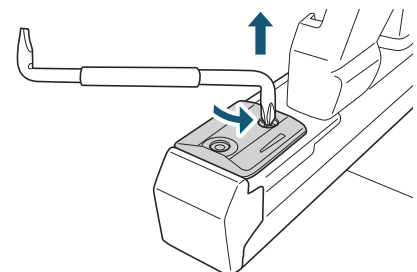

2. Use the brush to clean away any dust or waste thread that may have accumulated around the thread trimming knife.

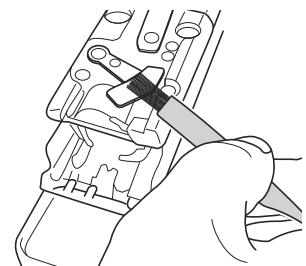

3. After cleaning is finished, attach the needle plate to the bed, and use the Phillips end of the Z-shaped screwdriver to fasten the screws.



### ■ Inside the rotary hook

1. Use the brush to clean away any dust or waste thread that may have accumulated inside the rotary hook.

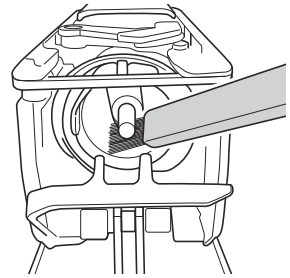

### ■ Inside the bobbin case

1. Use the brush to clean away any dust or waste thread that may have accumulated inside the bobbin case.

### ■ Tension base

1. Use the brush to clean away any dust or waste thread from places where the upper thread passes.

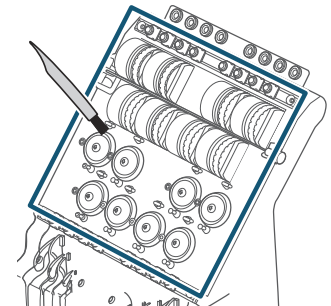

## 8.2.2 Lubrication

The places shown below must be oiled on a routine basis.

Places to oil	Frequency	Supplied accessories used
Rotary hook race	With each use	Oil
All needle bars and felt inside needle bar case	Once a week	Flat head screwdriver (2.5 × 75) Oil
Moving parts in arm	Once a year	Phillips screwdriver (6 × 100) Oil

### Caution

- ⊘ Switch power off before beginning the task.
- ⊘ For lubrication, use either the supplied oil (TF) or commercially available sewing machine oil. Use of any other oil may lead to malfunction.
- ⊘ Do not apply too much oil. When there is too much oil, it can splatter and get the fabric or thread dirty and cause stains. If too much oil has been applied, use a cloth or the like to wipe it away.

### ■ Rotary hook race

1. Apply a few drops of oil to the rotary hook race.

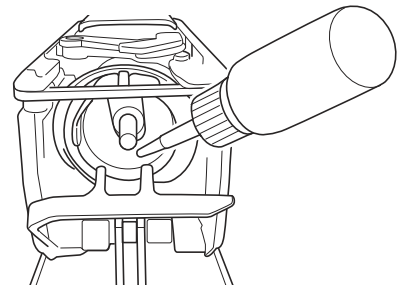

### ■ All needle bars and felt inside needle bar case

1. From the gaps in the take-up lever located in the upper part of needle bar case, apply a few drops of oil to the upper part of the needle bar.

Apply oil to all needle bars.

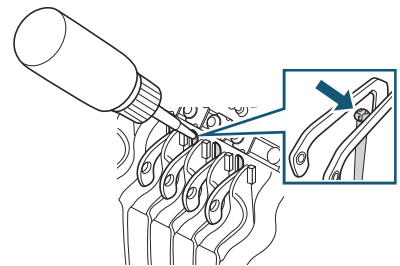

2. Use a flat head screwdriver (2.5 × 75) to remove the screws at right and left from the bottom cover, and remove the bottom cover.

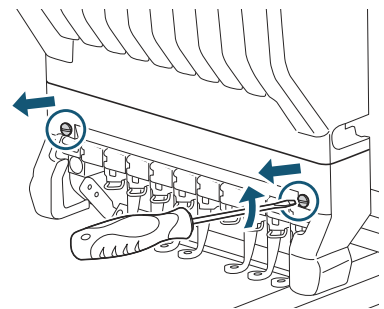

3. Apply a few drops of oil to the felt in the needle bar case.

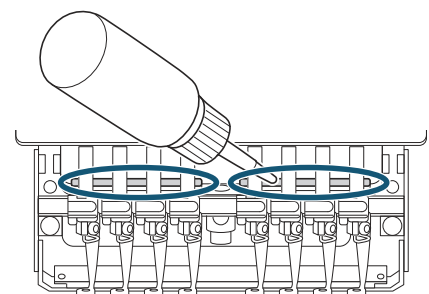

4. Once the lubrication is completed, replace the bottom cover and fasten the screws at right and left using a flat head screwdriver (2.5 × 75).

#### Caution



Be careful not to pinch any of the wires inside the needle bar case when installing the bottom cover.

## ■ Moving parts in arm

1. Remove the caps from the screws at two places on the cover on the right side.

 The screw caps can be removed more easily if you insert tweezers or other narrow-tipped objects into the hole.

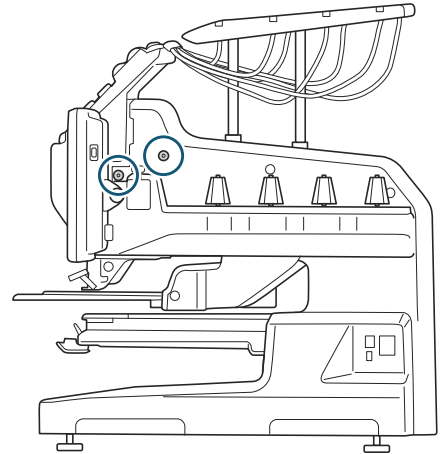

2. Use a Phillips screwdriver (6 × 100) to remove the screws in two places and remove the side cover.

3. Apply a few drops of oil at the locations shown in the illustration below.

- Vicinity of lubrication hole on shaft: (a)
- Moving part of lever: (b)
- Gold colored bushing: (c)

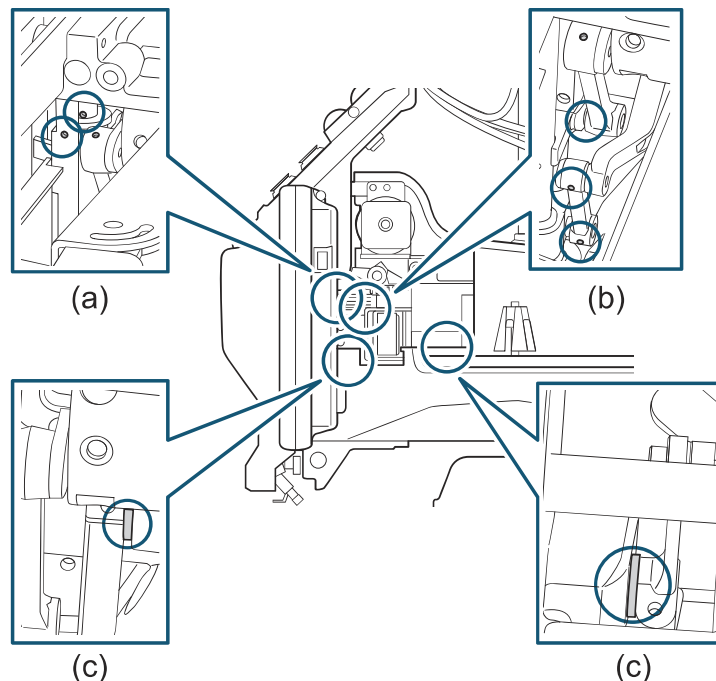

4. Once the lubrication is completed, replace the right side cover and fasten the screws in both places using a Phillips screwdriver (6 × 100).
5. Re-attach the caps over the screws.

## 8.3 Troubleshooting

The following explains the measures you should take when an error message is displayed, when you are unable to achieve the intended sewing results, or when other problems are encountered.

### 8.3.1 What to do when an error message is displayed

When the machine is operated incorrectly, or an abnormality occurs, the machine stops, and a message screen is displayed on the operation panel.

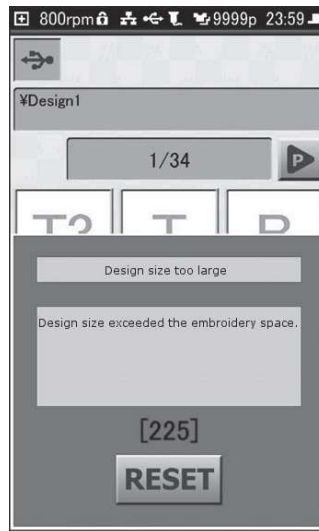

After checking the message and code that is displayed in the message screen, take the appropriate measures.

To dismiss the message screen, tap [RESET] in the message screen.

 In some cases, depending on the type of error, the screen will not go away even if you tap [RESET] on the message screen. In such cases, turn off the machine's power, then turn it back on.





#### ■ When a green message screen is displayed

This does not mean the machine stopped due to an abnormality or malfunction. Embroidery can be continued.



Code	Message	Measures to take
1B1	Stop by frame stepping code	Carry out one of the measures below, and then continue with the machine's operation. <ul style="list-style-type: none"> <li>• Press the [START]/[STOP] button on the operation panel</li> <li>• Advance/return frame operations</li> </ul>  <b>"4.9 Returning frame/advancing frame according to design"</b>
1B2	Stop by Color Change	
1B3	Stop by end code	
1B4	Stop by thread trimming code	
1B6	Stop by automatic offset code	
1B8	Stop by temporary stop code	
1C1	Stop by stop switch	

## ■ When a red message screen is displayed

These are displayed when settings for the machine are incorrect or it was not operated correctly. They can also be caused by a malfunction in the machine itself or by communication errors.

Code	Message	Measure to take
211	Fixed position signal error Fixed position signal cannot be detected.	Trim the thread manually, then return the main shaft to the fixed position.  <b>"4.10.3 Trimming the thread manually"</b> If the issue cannot be resolved, contact your sales dealer.
221	Frame Too Far Left The embroidery frame moved to the limit position (left)(+X direction).	Move the frame so as to make it possible to carry out embroidery within the limits of the frame.  <b>"4.10.1 Moving the frame manually"</b>
222	Frame Too Far Right The embroidery frame moved to the travel limit position (right)(-X direction).	
223	Frame Too Far Front The embroidery frame moved to the limit position (front)(+Y direction).	
224	Frame Too Far Back The embroidery frame moved to the travel limit position (rear)(-Y direction).	
225	Design size too large Design size exceeded the embroidery space.	Tap [RESET] and check the position of the frame.
281	Color change error Color change detection time, exceeded.	Stop use of the machine and contact your sales dealer.
291	Upper Thread Break The machine detected thread breakage.	Check the thread. If the thread is broken, replace the thread. Also, the tension base should be cleaned. If the issue cannot be resolved, contact your sales dealer.  <b>"2.2 Threading the upper thread", "2.3 Setting the under thread", "8.2.1 Cleaning the machine"</b>
293	Bobbin Thread Break The machine has detected under thread breakage.	Check to see if the bobbin has run out of thread, or if the under thread has broken. If the bobbin has run out of thread, or if there isn't much thread left, replace the bobbin with a new one. If the under thread is broken, replace it.  <b>"2.3 Setting the under thread"</b>
2B1	Networking error Not connected with Network	Check to make sure that the LAN cable is connected properly, and that the settings on the PC or other devices are appropriate.
2B3	Data found in end code Data is found in end code.	Modify the design using the dedicated design creation software or an optional DG product.
2B4	Function code error Function code error	
2B7	Data set incomplete Data set is not completed.	Select the design first, then start the embroidery.
2B8	Pre-reading buffer error Output data is not ready.	Modify the design using the dedicated design creation software or an optional DG product.
2BA	Memory capacity exceeded Memory capacity is insufficient.	Contact your sales dealer.

Code	Message	Measure to take
2BB	Frame back limit over Frame back reached the limit.	Do not return the frame any further.
2BE	Incorrect function code segment Functions with start/end are not registered in a pair of start and end.	Modify the design so that the start and end codes form a pair, using the dedicated design creation software or an optional DG product.
2C7	Password requested Input the password.	Contact your sales dealer.
2C9	Time setting error	Tap [RESET].
2CA	Power OFF/ON incomplete	Turn off the power, wait at least 5 seconds or more, then turn it back on.
2E3	Power failure during operation Power supply failed during operation.	Contact your sales dealer.
311	Encoder A signal error Encoder A signal does not vary.	
312	Encoder Z signal error Encoder Z signal does not vary.	Tap [RESET]. If the issue cannot be resolved, contact your sales dealer.
316	Main shaft motor error Main shaft motor or Motor driver is irregular.	Turn off the power, wait at least 5 seconds or more, then turn it back on. If the issue cannot be resolved, contact your sales dealer.
321	Frame driver irregular signal Frame driver irregular signal, detected.	
322	X-Driver irregular signal X-axis driver irregular signal, detected.	
323	Y-Driver irregular signal Y-axis Driver irregular signal, detected.	
32C	X-axis frame travel incomplete X-axis frame travel is incomplete.	
32D	Y-axis frame travel incomplete Y-axis frame travel is incomplete.	
32E	X-axis origin search incomplete X-axis origin search is incomplete in time.	Contact your sales dealer.
32F	Y-axis origin search incomplete Y-axis origin search is incomplete in time.	
354	Motor overcurrent Sequin, Zigzag cord	Carry out the procedure below. • Turn off the power, wait at least 5 seconds or more, then turn it back on. • Lower the rotation speed.
362	Jump motor overcurrent	 <b>"3.2.6 Selecting the speed"</b> If the issue cannot be resolved, contact your sales dealer.
382	Color change error in 1 sec. The needle position signal status during color change does not change for 1 second and more.	Contact your sales dealer.
383	Needle Position Error There was no needle position signal during rotation of the main shaft.	
3A6	Movable Knife Open ATH Knife retractable position has become nonuniform.	







Code	Message	Measure to take
3A9	Upper thread hook motor overcurrent	Turn off the power, wait at least 5 seconds or more, then turn it back on. If the issue cannot be resolved, contact your sales dealer.
3C1	Start/Stop switch error The power was turned ON in the state that the stop switch has been accidentally pressed.	Contact your sales dealer.
3D6	CPU card error Software installation error	
3DB	System RAM insufficient capacity CPU card	Turn off the power, wait at least 5 seconds or more, then turn it back on. If the issue cannot be resolved, contact your sales dealer.
3DC	Memory device error CPU card (Memory device)	
3DD	System software installation error CPU card (Memory device)	Contact your sales dealer.
3DE	External memory device error USB memory	Carry out the procedure below. <ul style="list-style-type: none"> <li>• Turn off the power, wait at least 5 seconds or more, then turn it back on.</li> <li>• Replace with a different USB memory (USB flash drive).</li> </ul> If the issue cannot be resolved, contact your sales dealer.
3DF	Memory device broken Time-based Functional limit	Turn off the power, wait at least 5 seconds or more, then turn it back on. If the issue cannot be resolved, contact your sales dealer.
5B1	Design information error Data cannot be input. Information is not appropriate.	Check the design.
5B2	Networking error (Software) Not connected with Network software.	Check to make sure that the LAN cable is connected properly, and that the settings on the PC or other devices are appropriate.
5C1	Frame origin memory incomplete Frame origin memory is incomplete.	Carry out the procedure for memorizing the frame origin.  <b>"6.2.2 Memorizing the frame origin"</b>
6B5	Communication Error Communication Error	Contact your sales dealer.
6D1	Frame parameter file error Frame parameter file is irregular.	
B01	Formatting error Irregular formatting! Cannot read designs.	Use the design after copying it from the PC using a new USB memory (USB flash drive).
B04	Empty media error USB Memory is not inserted.	Connect the USB memory (USB flash drive) to the USB port on the machine.  <b>"3.2.1 Loading the design to be embroidered"</b>
BC1	Unregistered design No. Design No. is not found.	Copy the design from the PC to the USB memory (USB flash drive).
BF2	Network setting error Network setting is incorrect.	Correct the network addresses.  <b>"6.3 Performing network settings"</b>

## 8.3.2 What to do when the embroidery results are not as expected

Often, the cause of problems can be things such as the needle condition or the thread tension. Refer to the following and try to determine the source of the problem.

If the cause cannot be identified, or the problem persists even after the recommended measures have been taken, consult with your sales dealer.



### ■ Thread often breaks

Cause	Measure to take	Reference
Improper thread tension.	Adjust the tension of the upper thread and under thread.	 "3.3.2 Checking the tension of the upper thread", "2.3.2 Putting the bobbin in place"
Upper thread doesn't flow properly.	Replace the upper thread.	 "2.2 Threading the upper thread"
Direction of needle is bad. Needle is bent.	<ul style="list-style-type: none"> <li>Adjust the position of the needle so that its groove faces forward or slightly to the right.</li> <li>Replace needles.</li> </ul>	 "2.1 Replacing needles"
Adhesive from appliqué has stuck to needles.	<ul style="list-style-type: none"> <li>Remove the adhesive from the needles.</li> <li>Replace needles.</li> </ul>	 "2.1 Replacing needles"
<ul style="list-style-type: none"> <li>Rotary hook is dirty.</li> <li>The rotary hook has not been oiled.</li> </ul>	<ul style="list-style-type: none"> <li>Clean the rotary hook.</li> <li>Lubricate the rotary hook.</li> </ul>	 "8.2.1 Cleaning the machine"
Design data contains numerous tiny stitches 0.5 mm or less.	Eliminate the tiny stitches using the design creation software.	(*1)
The embroidering position with respect to the fabric is too high or is too low.	Reposition the fabric on the embroidery frame so that it only lightly touches the needle plate.	 "2.4.1 Mounting the fabric on the embroidery frame"
Needle bars have not been oiled.	Lubricate the needle bars (once per week).	 "8.2.2 Lubrication"
Height of presser foot inappropriate.	Adjust the height of the presser foot so it is matched with the height of the material.	(*2)



(\*1) For details, refer to the manual for the design creation software that is being used.

(\*2) For information on how to perform the adjustment, consult with your sales dealer.

### ■ Needle breaks





Cause	Measure to take	Reference
Improper thread tension.	Adjust the tension of the upper thread and under thread.	 "3.3.2 Checking the tension of the upper thread", "2.3.2 Putting the bobbin in place"
The density of satin stitches is extremely high.	Modify the design. Eliminate unnecessary basting.	(*1)
Fabric is too thick or too hard.	Use fabric that is more suitable for embroidery.	 "8.1 Producing beautiful embroidery"



Cause	Measure to take	Reference
Bobbin is deformed.	Replace the bobbin.	 "2.3.2 Putting the bobbin in place"
<ul style="list-style-type: none"> <li>• Tip of needle is smashed.</li> <li>• Needle not suitable for design or fabric being used.</li> </ul>	<ul style="list-style-type: none"> <li>• Replace with a new needle.</li> <li>• Replace with appropriately sized needle.</li> </ul>	 "2.1 Replacing needles"
Machine vibrates a lot.	Adjust the unevenness of the machine using the adjusters.	Setup Guide

(\*1) For details, refer to the manual for the design creation software that is being used.

### ■ Sewing results not good

Cause	Measure to take	Reference
Improper thread tension.	Adjust the tension of the upper thread and under thread.	 "3.3.2 Checking the tension of the upper thread", "2.3.2 Putting the bobbin in place"
Upper thread doesn't flow properly.	Replace the upper thread.	 "2.2 Threading the upper thread"
Fabric or thread not suitable for design being used.	Change the type of fabric or thread.	 "8.1 Producing beautiful embroidery"
The way in which the embroidery frame was set up, or the way the fabric was put in place was inappropriate.	<ul style="list-style-type: none"> <li>• Set up the embroidery frame correctly.</li> <li>• Make sure that the fabric is securely held in the embroidery frame.</li> </ul>	 "2.4.1 Mounting the fabric on the embroidery frame"
Needle size is inappropriate.	Replace with new needles of the appropriate size.	 "2.1 Replacing needles"

## 8.4 Specifications

### ■ Machine main unit

Item	Details
Model	MDP-S0801C(200×300)S
Power supply	24V DC
Rated current	3.8 A
Rated electrical power	92 W
Weight	37 kg

### ■ AC adapter

Item	Details
Electricity	Input: 100 to 240V AC ( $\pm 10\%$ ), 3 A (Max.), 50–60 Hz Output: 24V DC, 7.5 A, 180 W
Machine connected	1.0 A (120 V), 100 W, 110 VA

# Index

## A

Attach an embroidery frame 26

## B

Barcode reader 15, 48

Bed 14

Bobbin 23

Bobbin case 23, 95

Bring frame out 58

## C

Cap fame 86

Cap frame unit 86

Change needle position 61

Cleaning 94

Conditions governing thread trimming 72

## D

Date/time setting 81

Design creation software 47, 48, 64

Design orientation 32

Display Language 82

## E

Error message 98

## F

Favorite 44

Frame limit 77

Frame movement 33

Frame setting 73

## H

Hiding icon 43

Home screen 16

## L

LAN cable 47, 48

LAN port 15

Laser crosshair marker 63, 72

Letter embroidery 65

Load a design 29

Lubrication 95

## M

Machine information 83

Machine main unit 14, 15

Maintenance function 85

Manual 60

Memorize frame origin 74, 76

Mounting the fabric on the embroidery frame 25

Move frame manually 60

## N

Needle bar case 14

Needle number 19, 31, 50, 51

Needle replacement 18

Network settings 79

## O

Operation panel 14

## P

Pause 53

PC 47, 48

Power inlet 15

Power switch 15

## R

Records 46

Return frame to the original position 78

Return frame/advance frame 59

Return stitches 71

Rotary hook 14, 24

## S

Sewing speed 35

Specifications 104

[START] button 14, 37

Start point 32

Step 31, 49

[STOP] button 14, 38

## T

- Thread breakage detection 70
- Thread breakage detection disk 20
- Thread color 55
- Thread course 14
- Thread guide 20
- Thread pressing shaft 19
- Thread stand 14
- Thread tension 14, 41
- Thread trim length 71
- Thread tube 14
- Trace 34
- Trim thread manually 62

## U

- Under thread setup 23
- Upper thread setup 19
- Upper thread tension 41
- USB port 15

## W

- Wallpaper color 84





**Manufactured by: Tokai Industrial Sewing Machine Co., Ltd.**

NO.1800, Ushiyama-cho, Kasugai, Aichi-pref., 486-0901, Japan

Telephone:568-33-1161 Fax:568-33-1191

**Distributed by: Tajima Industries Ltd.**

19-22, Shirakabe, 3-chome, Higashi-ku, Nagoya, 461-0011, Japan

Telephone:52-932-3444 Fax:52-932-2457